

AI-FR

Fixed Port Active Hubs for Redundant Fiber Ring Topology in ARCNET® Local Area Networks

INSTALLATION GUIDE

INTRODUCTION

Traditionally, ARCNET has been cabled as either a star or bus network, but never as a ring. However, under certain conditions a ring topology is possible. The ring has merit when the goal is to provide redundant cabling so that continuity can be preserved in the event of cable failure. If one cable becomes disabled for any reason, another is still available to pass messages. It is for this purpose that the AI-FR has been developed and implemented to achieve fiber optic redundancy in an otherwise un-redundant networking technology.

The AI-FR utilizes the same robust hub timing electronics found in Contemporary Controls' MOD HUB series of modular active hubs. This includes precision delay line timing, digitally controlled for dependable operation and reduced bit jitter.

The AI-FR is an application specific active hub that provides integrity status of the redundant fiber backbone. Redundant network topology — defined as a fiber optic ring with a local drop — is ideally established with three-port hubs, each incorporating the principle of fault monitoring.

A fiber backbone ring up to 2 km in size and employing up to four AI-FR hubs is possible. By decreasing the total fiber ring size, additional AI-FR hubs can be attached to the network allowing more devices to share the redundant ring.

The AI-FR operates from either low voltage AC or DC power. For DC operation, a voltage source in the range of 10 to 36 volts is required. For AC operation, the source must be in the range of 8 to 24 volts. Redundant power supplies can be attached for critical applications.

The hub is available in two versions. The AI-FR/CXB hub provides fiber ring continuity with a coaxial bus local drop while the AI-FR/TB5 accommodates a drop established by twisted-pair bus.

CONTEMPORARY CONTROLS®

SPECIFICATIONS

<i>Electrical</i>	DC	AC
Input voltage:	10–36 V	8–24 V
Input power:	4 W	4 VA
Input frequency:	N/A	47–63 Hz

Fault Relay Contacts

Max current and voltage:	500 mA	200 V
--------------------------	--------	-------

Environmental

Operating temperature:	0°C to +60°C
Storage temperature:	-40°C to +85°C

Data Rate

AI-FR hubs operate at 2.5 Mbps.

Timing

AI-FR delay time:	330 ns maximum at 2.5 Mbps
Unlatch delay time:	11.9 μs at 2.5 Mbps

Optical Power Budget (-FOG 850 nm at 25°C)

50/125 microns	6.6 dB
62.5/125 microns	10.4 dB
100/140 microns	15.9 dB

Dimensions

5.45" x 6.14" (139 mm x 156 mm)

Compatibility

Compliant with ANSI/ATA 878.1

Shipping Weight

2lbs. (.9kg)

Regulatory Compliance

CE Mark
CFR 47, Part 15 Class A

Mechanical

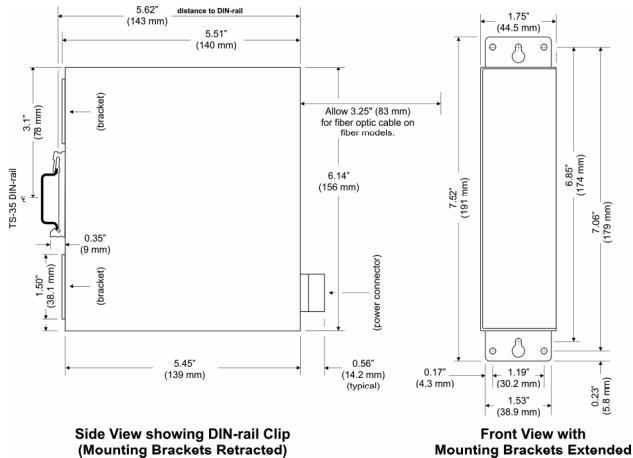

TD675300-0ID

INSTALLATION

AI-FR hubs are intended to be panel mounted in an industrial enclosure or wiring closet with two #8 pan head screws (not provided). Optionally, a DIN rail mount can be used by purchasing a DIN rail mounting kit.

Electromagnetic Compliance

This equipment is intended for nonresidential use. Operation in a residential area is likely to generate electrical interference unless corrective measures are undertaken by the user.

Powering

AI-FR hubs require either low voltage AC or DC power via a four-pin removable keyed connector. Consult the specifications for power requirements. The various power options are explained below.

DC Powered

AI-FR hubs accept a voltage range of 10–36 VDC and draw a current value commensurate with 4-watt power consumption. Power conductors should be sized accordingly. Ground is directly connected to zero volts and the equipment chassis is isolated from zero volts. The input connections are reverse-polarity protected.

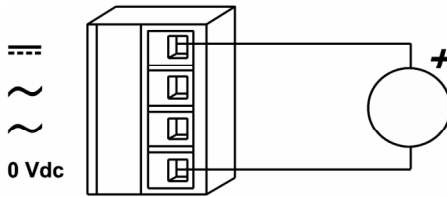

Figure 1 — DC Powered

Redundant DC Powered

Redundant diode-isolated DC power inputs are provided so the AI-FR can operate despite the loss of primary power. Either source must provide 4 watts, but the currents drawn from the two supplies may differ.

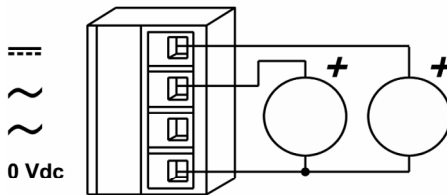

Figure 2 — Redundant DC Powered

AC Powered

The AI-FR can be powered by an AC voltage in the range of 8–24VAC capable of delivering 4 VA of apparent power. Two auxiliary power supplies are available: The AI-XFMR is for a 120 VAC. The AI-XFMR-E is for 230 VAC.

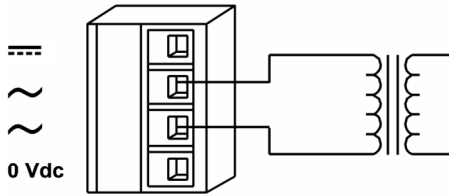

Figure 3 — AC Powered

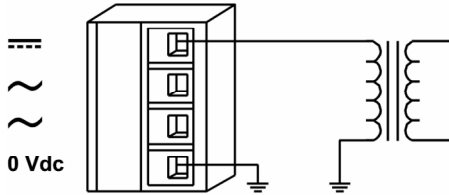

Figure 4 — AC Powered with Grounded Secondary

AC Powered with Battery Backup

The AI-FR can also operate in the AC mode with a backup battery providing power if the AC source fails. The AI-FR does NOT charge the battery so separate provisions are required for charging.

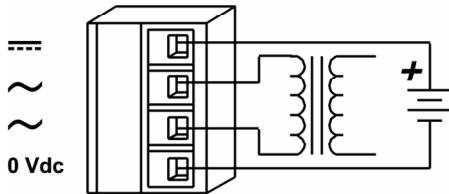

Figure 5 — AC Powered with Battery Backup

Connecting Cables

Each AI-FR hub provides fiber ring continuity with either a coaxial bus (/CXB) or twisted-pair bus (/TB5) local drop.

Connecting the Fiber Optic Cable

Bayonet-locking-style ST connectors (mechanically similar to BNC coaxial cable connectors) are provided for attaching fiber optic cable (typically multimode) of 50/125, 62.5/125, or 100/140 in size.

Connecting Coaxial Cable Bus Networks (-CXB)

The AI-FR/CXB allows RG-62/u coaxial cabling to various nodes via BNC “T” connectors at each device. *Each* end of a segment *must* be terminated with 93 ohms of passive resistance using a BNC terminator (BNC-TER). If the AI-FR occupies one end of the bus, it also must have the added termination. Make sure that all devices are -CXB compliant.

Connecting Shielded Twisted-Pair Bus Networks (-TB5)

The AI-FR/TB5 has dual RJ-45 connectors for communication with various nodes via shielded twisted-pair cable. *Each* end of a segment *must* be terminated with 100 ohms of passive resistance using a TB5 terminator (TB5-TER). If the AI-FR occupies one end of the bus, it also must have the added termination.

Determining Maximum Ring Length for the AI-FR/TB5

Formula:
$$\text{Max Ring Length} = \frac{11.9 \mu\text{s} - (\text{Number of Hubs} \bullet 330 \text{ ns})}{5 \text{ ns}}$$

Table: *Max Ring Length versus Hub Count*

<u>Number of Hubs</u>	<u>Max Ring Length</u>
2	2248
3	2182
4	2116
5	2050
6	1984
7	1918
8	1852
9	1786
10	1720

OPERATION

In IDLE state, the AI-FR hub awaits an ARCNET signal with all its receivers enabled and all transmitters disabled. As soon as one of its ports senses a signal, the hub becomes ACTIVE, thus keeping that receiving port enabled while disabling all other receivers. Conversely, all hub transmitters are enabled except that of the receiving port.

The unlatch delay (which squelches any recirculating message) has been increased from 5.9 μs to 11.9 μs . Hence, total delay due to fiber propagation (5 ns/m) and the number of AI-FR hubs (330 ns/hub) must be less than 11.9 μs . After 11.9 μs have elapsed without a logic “1” being received, the hub assumes the source has finished transmitting. The hub then “unlatches,” switching from the ACTIVE to the IDLE state.

With a fiber ring properly configured, activity will be present on both backbone ports. The AI-FR will latch the first active port and block the other. If both ports receive simultaneous data, priority is given to port 2.

Fault Monitoring

If something disrupts normal operation, a watchdog timer (sensing no hub activity after a preset time) automatically resets its timing circuitry to ensure that the hub reestablishes communication.

If a fiber fails, the AI-FR will sense no activity within 250 ms and open the screw terminals of the front-panel relay connection (refer to figure 6 below). By monitoring these terminals, fiber faults can be detected. If the hub locks on one port for more than 1.2 seconds (possibly due to circulating noise), a second watchdog timer interprets this as a lockup, clears the hub and restores normal operation.

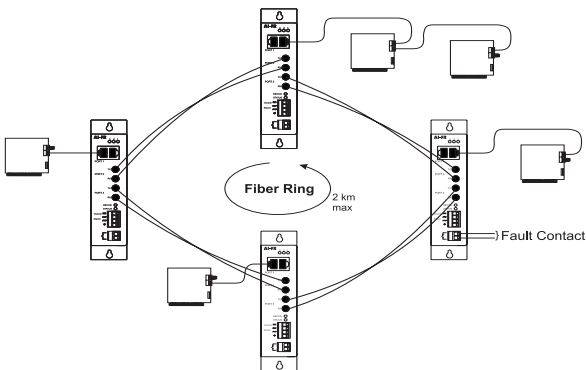

Figure 6 — Fiber Ring Field Connections

LED Indicators

There are several LEDs on the AI-FR which indicate network operation and help problem diagnosis:

ACTIVITY LEDs 1, 2 and 3

Just above the local drop connectors are three numbered LEDs which indicate ARCNET traffic is being *received* on the respective ports. (Port *transmissions* do not light any LEDs.) The brighter the LED, the greater its port traffic.

STATUS (green)

Properly powered and connected *but with no valid ARCNET activity* on any port, this LED will flash at a periodic rate in the idle condition. When lit continuously, this LED indicates that ARCNET traffic is being received *and faithfully regenerated* to the other ports on the hub.

RECON (yellow)

As nodes enter or leave the network, this LED will flash to report a routine reconfiguration of the network. Reconfigurations are not sensed, but *assumed* when no data has occurred for 82 ms. Reconfiguration takes a fraction of a second, but the LED glows for one second for ease of viewing. Occasional flashes are normal as automatic reconfigurations take place, but a constant or frequently flashing LED could indicate a faulty network interface module; defective cable; duplicate node IDs; or excessive electrical interference.

Troubleshooting with LEDS

ACTIVITY LED fails to light: This may indicate the cable is disconnected or open, the cable is attached to a defective node, or the hub port is bad. Test the hub port by swapping its cable with another cable attached to a port known to function properly. If the symptom follows the cable, the port is good and a node or cable problem is indicated.

ACTIVITY LED glows excessively: A “chattering node” (one with a defective receiver) causes continuous reconfigurations. The AI-FR indicates a bad node by a bright ACTIVITY LED (other port ACTIVITY LEDs will be dim) and a constantly lit RECON LED. Detaching the cable associated with the bright LED will extinguish the RECON LED and return other port ACTIVITY LEDs to normal brightness, thereby confirming the defective node.

STATUS LED fails to light despite receiving valid ARCNET traffic: This indicates a defective AI-FR hub.

DECLARATION OF CONFORMITY

Applied Council Directives:

Electromagnetic Compatibility Directive, 89/336/EEC Council Directive as amended by Council Directive 92/31/EEC & Council Directive 93/68/EEC

Standard to which Conformity is Declared

EN 55022:1995 CISPR22: 1993, Class A, Limits and Methods of Measurement of Radio Disturbance Characteristics of Information Technology Equipment

EN 55024:1998, Information Technology Equipment — Immunity Characteristics — Limits and Methods of Measurement

Manufacturer:

Contemporary Control Systems, Inc.
2431 Curtiss Street
Downers Grove, IL 60515 USA

Authorized Representative:

Contemporary Controls Ltd
Sovereign Court Two
University of Warwick Science Park
Sir William Lyons Road
Coventry CV4 7EZ
UNITED KINGDOM

Type of Equipment:

Industrial local area network fiber-ring hub

Model	Directive
	EMC
AI-FR/CXB	Yes
AI-FR/TB5	Yes

Manufacturer's Declaration: I, the undersigned, hereby declare that the product(s) specified above conforms to the listed directives and standards.

George M. Thomas, President

September 22, 2000

NEED MORE HELP INSTALLING THIS PRODUCT?

More information can be found on our web site at www.ccontrols.com. Browse the Technical Support section of our site for a look at our interactive on-line technical manuals, downloadable software drivers and utility programs that can test the product. When contacting one of our offices, ask for technical support.

Warranty

Contemporary Controls (CC) warrants its new product to the original purchaser for two years from the product shipping date. Product returned to CC for repair is warranted for one year from the date that the repaired product is shipped back to the purchaser or for the remainder of the original warranty period, whichever is longer.

If a CC product fails to operate in compliance with its specification during the warranty period, CC will, at its option, repair or replace the product at no charge. The customer is, however, responsible for shipping the product; CC assumes no responsibility for the product until it is received.

CC's limited warranty covers products only as delivered and does not cover repair of products that have been damaged by abuse, accident, disaster, misuse, or incorrect installation. User modification may void the warranty if the product is damaged by the modification, in which case this warranty does not cover repair or replacement.

This warranty in no way warrants suitability of the product for any specific application. IN NO EVENT WILL CC BE LIABLE FOR ANY DAMAGES INCLUDING LOST PROFITS, LOST SAVINGS, OR OTHER INCIDENTAL OR CONSEQUENTIAL DAMAGES ARISING OUT OF THE USE OR INABILITY TO USE THE PRODUCT EVEN IF CC HAS BEEN ADVISED OF THE POSSIBILITY OF SUCH DAMAGES, OR FOR ANY CLAIM BY ANY PARTY OTHER THAN THE PURCHASER.

THE ABOVE WARRANTY IS IN LIEU OF ANY AND ALL OTHER WARRANTIES, EXPRESSED OR IMPLIED OR STATUTORY, INCLUDING THE WARRANTIES OF MERCHANTABILITY, FITNESS FOR PARTICULAR PURPOSE OR USE, TITLE AND NONINFRINGEMENT.

Returning Products for Repair

Before returning a product for repair, contact Customer Service. A representative will instruct you on our returns procedure.

Contemporary Control Systems, Inc.	Contemporary Controls Ltd
2431 Curtiss Street	Sovereign Court Two
Downers Grove, Illinois 60515 USA	University of Warwick Science Park
Tel: +1-630-963-7070	Sir William Lyons Road
Fax: +1-630-963-0109	Coventry CV4 7EZ UK
E-mail: info@ccontrols.com	Tel: +44 (0)24 7641 3786
WWW: http://www.ccontrols.com	Fax: +44 (0)24 7641 3923
	E-mail: info@ccontrols.co.uk