

ANA

ARCNET Protocol Analyzer

User Manual

TD000700-0ME

CONTEMPORARY  **CONTROLS**[®]

Table of Contents

1.	<i>Introduction</i>	5
2.	<i>Overview of ARCNET Analyzer</i>	6
3.	<i>Specifications</i>	7
3.1.	Host Computer Minimum Requirements	7
3.2.	Physical	7
3.3.	Environmental	7
3.4.	Functional	7
3.5.	Electrical	7
3.6.	Compliance	7
4.	<i>Installing ARCNET Analyzer</i>	8
4.1.	Component List	8
4.2.	Installation of Hardware	9
4.2.1.	Connection to Power	9
4.2.2.	Connection to the Host Computer.....	9
4.2.3.	Connection to the Fieldbus	10
4.2.3.1.	Connecting to Coax	10
4.2.3.2.	Connecting to Twisted-Pair.....	10
4.3.	Installation of Software	11
5.	<i>Configuring ARCNET Analyzer</i>	12
5.1.	Configuring the Port Transceiver in Hardware	12
5.2.	Configuring the Port Transceiver in Software	13
5.3.	Configuring the Data Rate	14
5.4.	Configuring the Filter	14
5.5.	Configuring the Device Number	14
5.6.	Configuring Triggers	15
5.6.1.	Specifying Triggers in a Packet Frame	18

6.	<i>Using ARCNET Analyzer</i>	20
6.1.	Starting ARCNET Analyzer	20
6.2.	LED Indicators	20
6.2.1.	Power LEDs.....	20
6.2.2.	Data LEDs	20
6.3.	Adjusting Signal Sensitivity	21
6.3.1.	Coaxial Signal Receiver Sensitivity — R92.....	21
6.3.2.	EIA-485 Signal Receiver Sensitivity — R50	21
6.3.3.	Isolated Trigger Sensitivity — R84	21
6.4.	The Main Display	22
6.4.1.	Display Modes	22
6.4.1.1.	Normal Mode.....	22
6.4.1.2.	Scroll Mode	22
6.4.2.	The Data Window	23
6.4.3.	Captured Packet Detail	24
6.5.	Operating Modes	26
6.5.1.	Auto Restart Mode	26
6.5.2.	Packed Mode.....	26
6.6.	Capturing Data	26
6.6.1.	Capture Buffer	26
6.6.2.	Trigger Position and the Capture Buffer	27
6.6.3.	Analyzer States	29
6.6.3.1.	Idle	29
6.6.3.2.	Capturing Data.....	29
6.6.3.3.	Waiting for Trigger.....	29
6.6.3.4.	Trigger Found, Capturing Data	30
6.6.3.5.	Capture Stopped	30
6.6.3.6.	Capture Complete	30
6.6.4.	Ending and Saving a Capture Session.....	31
6.6.4.1.	Stopping Capture	31
6.6.4.2.	Saving Captured Data	31
6.6.4.3.	Clearing the Captured Data	31
6.6.5.	Search Function.....	31

7.	<i>Service</i>	32
7.1.	Warranty	32
7.2.	Technical Support	32
7.3.	Warranty Repair	33
7.4.	Non-Warranty Repair	33
7.5.	Returning Products for Repair	33
8.	<i>Appendices</i>	34
8.1.	Declaration of Conformity	34
8.1.1.	Applied Council Directives:	34
8.1.2.	Standard to which Conformity is Declared	34
8.1.3.	Manufacturer:.....	34
8.1.4.	Authorized Representative:	34
8.2.	Removing ARCNET Analyzer from the Host Computer	34
8.3.	Frame Types	35
8.4.	How Frames and Frame Elements Count as Triggers	35
8.5.	Abbreviations Used In This Manual	36
8.6.	Hot-Keys Used by ARCNET Analyzer	37
8.7.	File Extensions Used by ARCNET Analyzer	37
8.8.	Data Rate Considerations	37
8.9.	Using Multiple Instances of ARCNET Analyzer	38
8.10.	Launching ARCNET Analyzer with the DOS Option	38
8.11.	Error Messages	39

Introduction

ARCNET Analyzer is a powerful tool — part hardware, part software — for diagnosing network traffic, for designing networks and for developing and debugging associated equipment. It captures and displays **all** ARCNET control and information frames—and stores them for later retrieval and analysis. Both normal and packed data modes are supported.

The USB Module is the physical device which communicates with the host computer through one USB port while employing an embedded Intel 386 to process all ARCNET control and information frames captured from the LAN. Acquired data is stored in 512 kB of onboard RAM and may be exported to disk in a data file for subsequent off-line analysis.

Fieldbus connectors are available for coax, twisted-pair and both AC- and DC-coupled EIA-485 communication. Traditional coaxial cable is coupled through a BNC connector. Connectors for twisted-pair and EIA-485 communication include two RJ-11 jacks (to facilitate daisy-chaining) and one terminal for attaching wires with screw-connectors.

Controls are provided for optimizing transceiver coupling and LEDs indicate the various operational states or the occurrence of a hardware error. A screw-connector offers a choice between an optically-isolated or a non-isolated input of an external signal for initiating data capture.

The Software Module displays either real-time captured data or frames that have been previously acquired, saved and retrieved for analysis. Data capture is controlled by GUI options for data rate, protocol, filter, and trigger criteria.

All standard data rates—up to 10 Mbps—are supported and are selectable through a convenient pop-up menu. Every captured frame receives a time stamp which allows accurate time analysis of the acquired data. At the user's discretion, time stamping can be either absolute or relative—with resolution variable to 2.5 μ s.

Flexible triggering options permit diverse strategies for development and debugging. The user may choose to capture data acquired before the trigger, after the trigger, or both. Data capture is initiated when a user-specified trigger or combination of triggers is detected in the data stream. A list of up to 16 user-defined triggers can stipulate (as applicable) frame type, source ID, destination ID, packet length, and packet data. Triggering can be in response to any event within the unbounded traffic stream or limited to a particular window of opportunity established by an external control signal—either manually or automatically generated. Also, triggering can be set to report the presence of an ARCNET error (usually a reconfiguration burst) in the data stream.

Overview of ARCNET Analyzer

Figure 1 presents a quick look at the main features of the Main Display.

High resolution Time Stamp of all frames

Current state of operation is reported on screen

Large on-board memory for real-time storage of ARCNET frames

Message Index reports position of the top line of display window

Locate trigger quickly with Trigger Position

Search function will find any character string in the acquired data

ARCNET Analyzer

File Edit View Options Help

Time Stamp
 Absolute
 Relative

Analyzer State
Capturing Data

Captures
15565

Message Index
7681

Trigger Position
7683

Find

 Up Down

Time Stamp(s)	T	Type	SID	DID	Length	SC	Data(0~507 Bytes)
0000000.9109600		FBE	--	C0			
0000000.9109900		ACK					
0000000.9110100*		PAC	A9	C0	150	F9	FA FB FC FD FE FF 00 01 02 03 04 05 0
0000000.9125400		ACK					
0000000.9152500		FBE	--	C0			
0000000.9152800		NAK					
0000000.9153500		FBE	--	C0			
0000000.9153800		NAK					
0000000.9154600		FBE	--	C0			
0000000.9154900		NAK					
0000000.9155600		FBE	--	C0			
0000000.9155900		NAK					
0000000.9156700		FBE	--	C0			
0000000.9157000		NAK					
0000000.9157800		FBE	--	C0			
0000000.9158100		NAK					
0000000.9158800		FBE	--	C0			
0000000.9159100		NAK					
0000000.9159900		FBE	--	C0			
0000000.9160200		NAK					
0000000.9160900		FBE	--	C0			

Packed Mode

Trigger Position
 Top Center Bottom

Trigger Type
 List External Manual

Packed Mode compresses high volume traffic data for more efficient storage

Pause data display while data capture continues

Trigger can be set to occur at the top, centre and bottom of captured data

Trigger on data contained in an ARCNET frame

Trigger with an external device

Trigger on a mouse click

Figure 1 — Main Display

Specifications

Host Computer Minimum Requirements

Processor	Pentium 90 MHz
RAM	32 MB
Hard Disk	500 MB, 100 MB free
Operating System	Windows® 98, ME, 2000 or XP
Monitor	VGA — 800 x 600 pixel resolution
Removable Media	CD-ROM
Pointing Device	Mouse
Communications	At least one free USB 1.1 compatible port

Physical

Dimensions	8.25" L x 4.5" W x 1.5" H (210 mm x 115 mm x 38 mm)
Shipping Weight	2 lbs. (0.9kg)

Environmental

Operating Temperature	0°C to +60°C
Storage Temperature	-40°C to +85°C

Functional

Data Rates	10 Mbps, 5.0 Mbps, 2.5 Mbps, 1.25 Mbps, 625 kbps, 312.5 kbps, 156.25 kbps
External Trigger Input Limitation	
Non-isolated trigger	2–5 volts at 2 mA max.
Isolated trigger	5–24 volts (depends on setting of R84) 18–30 mA (depends on input voltage and setting of R84)

Electrical

Switching AC Power Adaptor	100–240 VAC, 50–60 Hz	5 VA
USB Module	5 VDC	500 mA

Compliance

Compatibility	Compliant with ANSI/ATA 878.1 – 1999
Regulatory Compliance	CE Mark

Installing ARCNET Analyzer

Component List

ARCNET Analyzer is shipped with one of each of the following items:

CD-ROM

USB Module

USB Data Cable

Switching AC Power Adaptor

Mains Power Cord

RJ-11 Terminator

BNC Terminator

BNC Tee

Removable Screw-Connector, 3-wire

Removable Screw-Connector, 4-wire



Installation of Hardware

Connection to Power

Mains voltage is connected to the AC power adaptor by means of a detachable power cord. The AC power adaptor — operating on input voltages ranging from 100 VAC to 240 VAC — supplies 5 VDC to the USB Module by means of a power cord which plugs into the 5 VDC Power Jack — located in **red** in **Figure 2**.

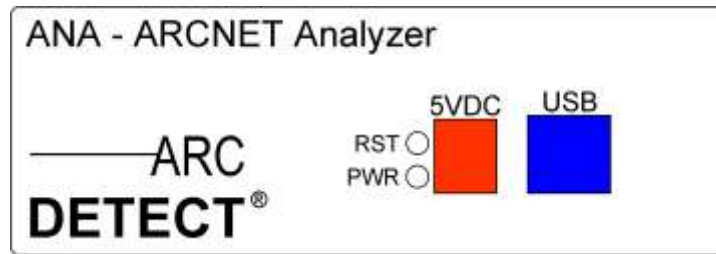

Figure 1 — Power and USB Connections

Connection to the Host Computer

One end of USB Data Cable should be attached to an available USB port on the host computer — the other end should be plugged into the USB Jack — located in **blue** in **Figure 2**. Once this connection has been made, the USB Module — if properly powered — will be detected immediately. At this point, Windows will prompt for a driver from the CD. After satisfying the Windows prompts, the USB Module will be ready for use. A reboot will not be needed to begin **ARCNET Analyzer** operation.

It is recommended that the USB Module connect directly to a USB port on a PC. The USB Module should not be connected to a hub.

Connection to the Fieldbus

ARCNET Analyzer is provided with four connectors allowing attachment to networks that are wired with either coaxial or twisted-pair cable. The default impedance of each connector is the proper value for **ARCNET Analyzer** to attach to the network as a **bus** device. If the **ARCNET Analyzer** occupies the end of a segment, proper termination must be **added** so that the port impedance matches the characteristic impedance of whatever type of cabling is in use. Terminators have been provided for this purpose. **NOTE:** The connectors are internally bussed together — therefore, a terminator should only be used when needed. To avoid improper impedance matching and data irregularities that may result, detach unneeded terminators and unused network cables.

Connecting to Coax

Traditional coax is coupled to the **ARCNET Analyzer** through a BNC Tee-connector attached to the BNC port — located in **orange** in **Figure 3**. If the **ARCNET Analyzer** connects as a bus device, no termination should be added. The two coax lines feeding the bus from either direction attach to the two connections made available by the Tee. On the other hand, if the **ARCNET Analyzer** is the last device on the bus, the coax line should attach to one part of the Tee and the BNC terminator should be installed on the other part of the Tee. The BNC terminator has a value of $93\ \Omega$ to match RG-62/u coaxial cable — the type of coaxial cable most often recommended for ARCNET.

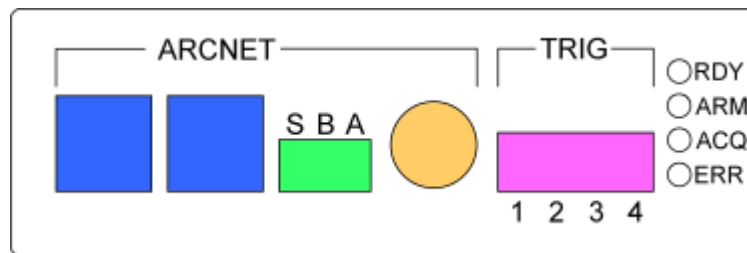

Figure 3 — Fieldbus Connections

Connecting to Twisted-Pair

Twisted-pair cable may be attached to either of the two RJ-11 modular jacks — located in **blue** in **Figure 3**. Alternatively, the end of a twisted-pair cable can be separated and the individual wires fastened to the 3-wire screw-connector provided for this purpose — located in **green** in **Figure 3**. The 3 letters printed above the connector designate the connection points for phase **A** (LINE+), phase **B** (LINE-) and the shield (**S**).

If the **ARCNET Analyzer** occupies the end of a segment, the RJ-11 terminator should be installed in one of the RJ-11 jacks. It provides $100\ \Omega$ of passive termination, a value which matches the characteristic impedance of most twisted-pair cable.

Daisy-chained connections are easily made with the two RJ-11 jacks. If daisy-chaining is desired with loose-wire connections to the screw-connector — located in **green** in **Figure 3** — simply double-up the individual wires from both cables — taking care to tie LINE+ to terminal A and LINE- to terminal B.

Pin assignments for RJ-11 connectors are listed in **Table 1** and illustrated in **Figure 4**.

PIN	TP	485	485X
1	—	—	—
2	N/C	N/C	N/C
3	LINE –	LINE –	LINE
4	LINE +	LINE +	LINE
5	N/C	N/C	N/C
6	—	—	—

Table 1 — RJ-11 Pin Assignments

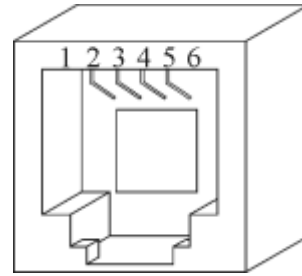

Figure 4 — RJ-11 Jack

NOTE: For the twisted-pair (TP) transceiver, LINE+ is defined at the leading positive phase of the dipulse signal. For the 485 transceiver, LINE+ is defined as the pin with the more positive applied failsafe bias. The 485X transceiver is not polarized.

Installation of Software

With Windows active and the CD inserted, run the **Setup.exe** file located in the **Setup** directory on the CD. As the automatic installation begins, follow the instructions on the screen as they appear. The installation procedure will offer a choice for the destination of **ARCNET Analyzer** files. If the user does not specify a destination folder with the **Browse** option, the following folder will be created by default:

C:\Program Files\Contemporary Control Systems, Inc\ARCNET Analyzer

After the file destination is specified, a Program Folder is chosen for the short-cut icons. The default Program Folder will be **ARCNET Analyzer**, but the user may specify another if desired. After specifying the Program Folder, the following files will be installed in the destination folder:

<u>FILE NAME</u>	<u>SIZE</u>	<u>DESCRIPTION</u>
AAdll.dll	84 kB	ARCNET Analyzer Data Link Library
Analyzer.exe	128 kB	ARCNET Analyzer Program
Uninst.isu	2 kB	ARCNET Analyzer Uninstall Instruction File

Upon completion of the software installation, the Windows Program Menu will now have **ARCNET Analyzer** (and its icon) as an option. The program may now be launched by selecting it from the Program Menu, but **ARCNET Analyzer** will need to be configured before the initial session of data acquisition.

Configuring ARCNET Analyzer

ARCNET Analyzer is preset at the factory to capture data from coaxial cable at 2.5 Mbps. Most operational features are determined by software settings, but changing the transceiver setting involves reconfiguring **both** the hardware and the software.

Configuring the Port Transceiver in Hardware

The USB Module has one bank of 9 DIP switches for specifying which transceiver will serve as the port for data capture. The switch bank is accessed by removing the cover of the USB Module and is located near the fieldbus connectors. Each illustration in **Figure 5** below depicts the settings needed to specify the port transceiver option printed to left of each switch. After setting the DIP Switches for the desired transceiver option, the USB Module is configured and the cover may be replaced.

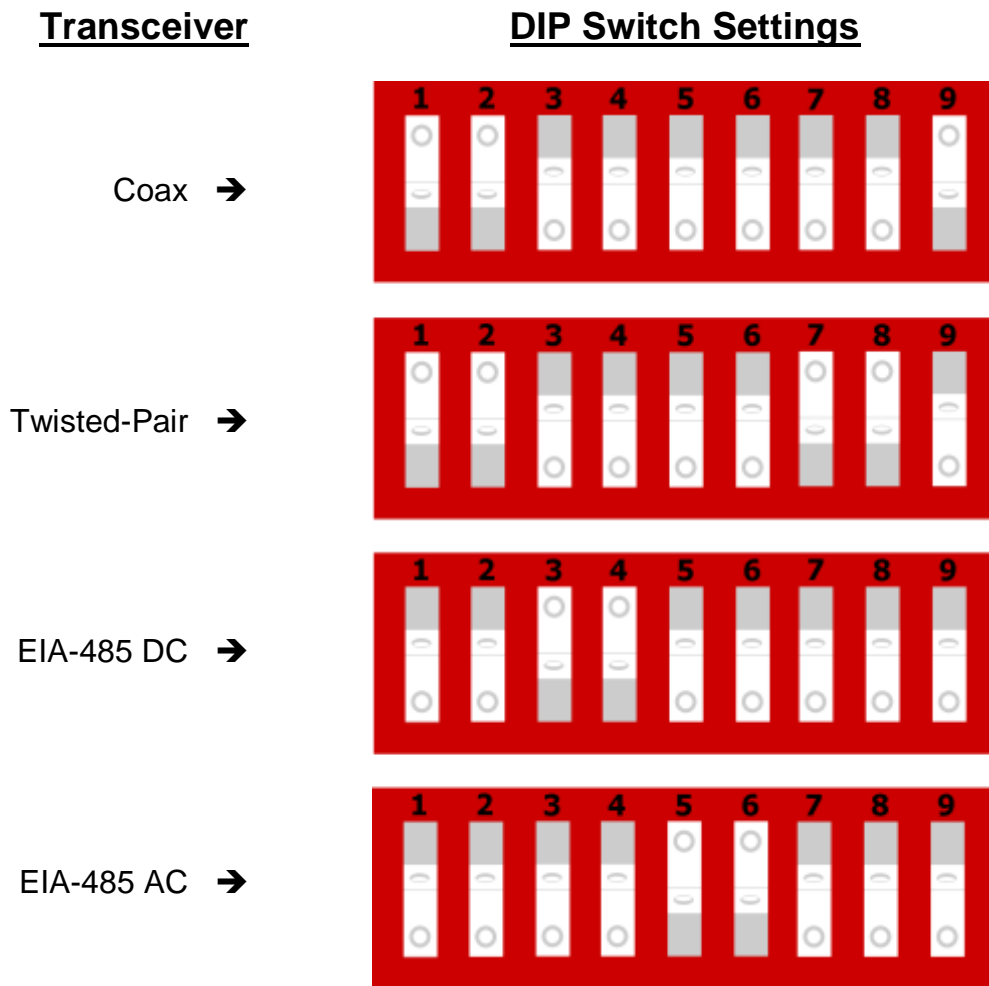

Figure 5 — DIP Switch Settings for Specifying the Port Transceiver

Configuring the Port Transceiver in Software

Under Windows, select **ARCNET Analyzer** from the **Start | Programs** menu structure. The **Main Display** will appear. To configure the Software Module, the USB Module **must be powered and connected** to the Host Computer with the USB cable.

After the **Main Display** appears, select the **Options** Menu. (As shown below, the **Normal Mode** is activated by default, but it is of no concern at this time.) Choose the **Settings** option as illustrated in **Figure 6** below:

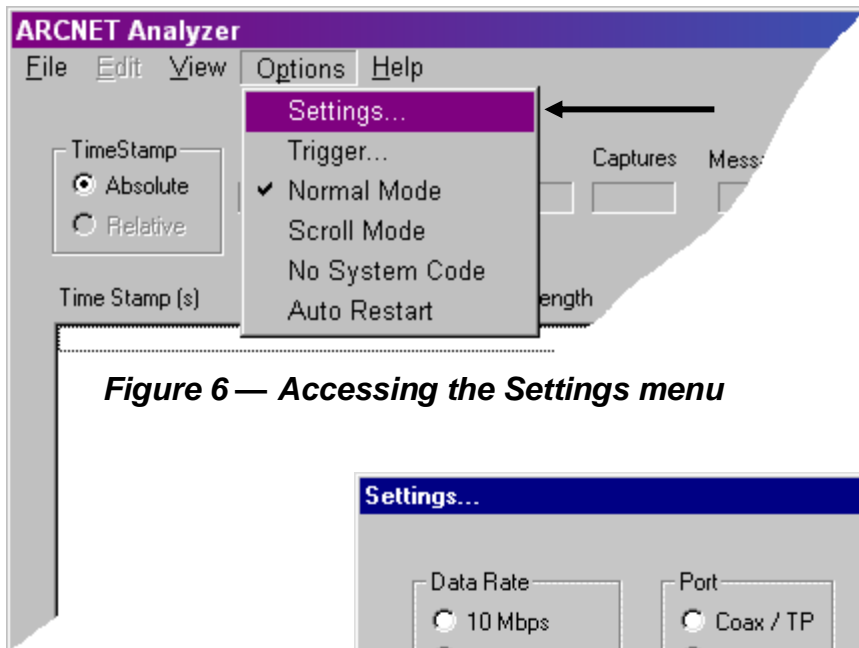

Figure 6 — Accessing the Settings menu

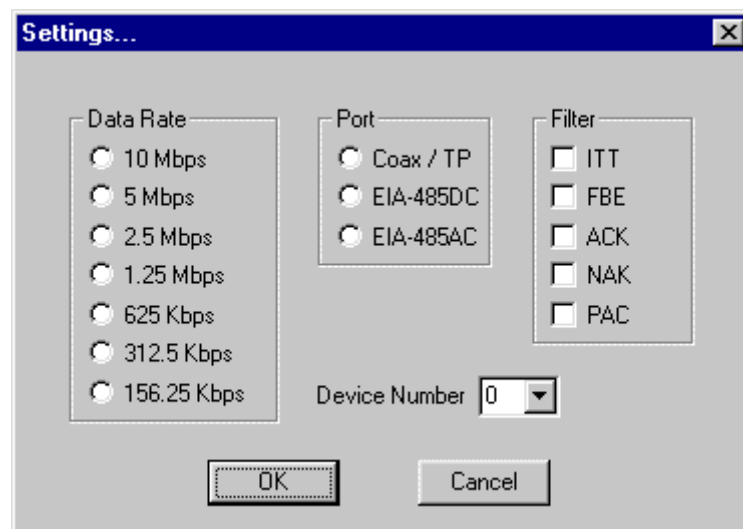

Figure 7 — Settings Menu Is Initially Unconfigured

Figure 7 displays the initial **Settings Menu** as it appears **before** any configuration has been done. When the program is first launched, the RAM in the USB Module will not have valid configuration data for these 3 settings. It will need to be updated with these settings from the Software Module before data acquisition can commence.

Note: Each time **ARCNET Analyzer** is terminated, the existing configuration is saved to the file *ana.cfg* to be used automatically the next time the program is launched.

The **centre** column in **Figure 8** below offers 3 transceiver choices: one for dipulse signalling (**Coax/TP**), and two for non-dipulse signalling (**EIA-485DC** and **EIA-485AC**). Transceiver characteristics are discussed in pages 10–15 of the accompanying ARCNET Tutorial. The transceiver selection **must match** the DIP switch configuration in the USB Module. If the network cabling protocol changes or if **ARCNET Analyzer** is moved to another network with different cabling, this software setting must be adjusted to match the new conditions.

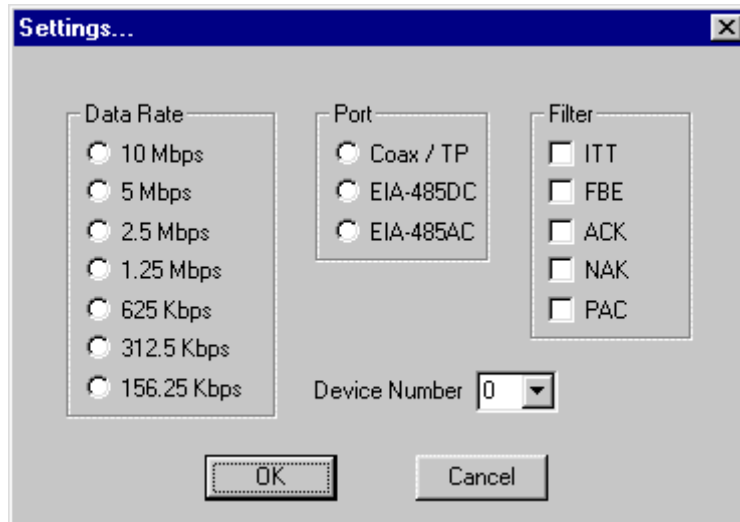

Figure 8 — Settings for Data Rate, Port, Filter and Device Number

Configuring the Data Rate

The **Data Rate** setting in **Figure 8** matches the data rate of **ARCNET Analyzer** to that of the network. In addition to the traditional fixed ARCNET data rate of 2.5 Mbps, the most common data rate multiples and sub-multiples are available. If the network data rate changes or if **ARCNET Analyzer** is moved to another network with a different data rate, this software setting must be adjusted to match the new rate. This is only a software setting — the USB Module does not have settings for the data rate.

NOTE: Some transceivers use only certain data rates as described in **Section 8.8**.

Configuring the Filter

In the **Filter** area of **Figure 8**, the user specifies which ARCNET frames are to be captured by **ARCNET Analyzer** during data acquisition. These options are ITT, FBE, ACK, NAK and PAC. Unchecked boxes specify frames which are ignored. **Any or all** frame types may be designated for capture, but **at least one must be specified**. Filtering is controlled purely by software, although the filtering process itself occurs in the USB Module.

Configuring the Device Number

One computer can run as many as 5 instances of **ARCNET Analyzer** simultaneously—each capturing data independently under a unique Device Number. The default value of “0” corresponds to a single instance. See **Section 8.9** for more information.

After the **Settings Menu** has been configured for Data Rate, Port, Filter and Device Number, click **OK** to download the configuration data to RAM in the USB Module. The process will take about ten seconds. **At start up** the user **must** specify a choice in every option column of the **Settings Menu** to initialize RAM with the configuration data. Unless all 3 columns have options selected, one or more of the following prompts will appear:

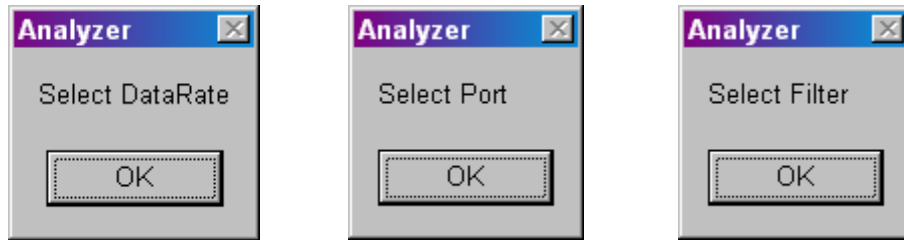

Figure 9 — Settings that Must Be Specified at Start Up

Until all settings are satisfied, program execution will not proceed beyond the **Settings Menu** and one or more of the prompts of **Figure 9** will continue to demand attention.

Configuring Triggers

The ability to trigger the capture of data is a prime feature of **ARCNET Analyzer** and offers great diversity in how data is captured and the nature of data acquired.

It is possible to operate **ARCNET Analyzer** without triggers — simply observing network traffic. This may be useful to confirm that traffic is occurring, but usually it is more desirable to specify a particular trigger or set of multiple triggers.

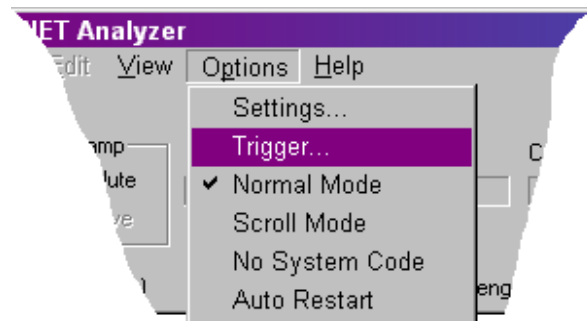

Figure 10 — Accessing the Trigger Menu

Triggers are of **two types**.

A **signal trigger** employs the occurrence of some signal voltage to begin the capture of data. The signal can be **External** — provided by a device attached to the USB Module — or the signal can be a **Manual** trigger generated in the host computer by clicking the **Manual Trigger** button on the **Main Display** of the Software Module.

NOTE: The **Manual Trigger** button is only visible if the **Manual** option is checked under the **Trigger Type** options in the lower right area of the **Main Display**.

Data triggers — which offer far more flexibility — cause data capture to begin when a particular ARCNET frame or some pattern of frames occurs within the data stream. With data triggers, a **Trigger List** of considerable complexity can be built.

Figure 10 above illustrates the “**Trigger ...**” option from the **Options** drop-down menu. This selection is **for setting data triggers**. When this choice is made, the user may access and specify several parameters as discussed and illustrated on the next page.

NOTE: For a trigger to work, the **Filter** setting (see **Figure 8**) must specify the type of frame being used as the trigger. For example, if a trigger specification includes the type **FBE**, the trigger will **only** work if **FBE** has also been selected in the **Settings Menu**.

When invoked for the first time, a blank **Trigger Display** appears as displayed in **Figure 11** below. The area in white is where trigger details are reported as they are set.

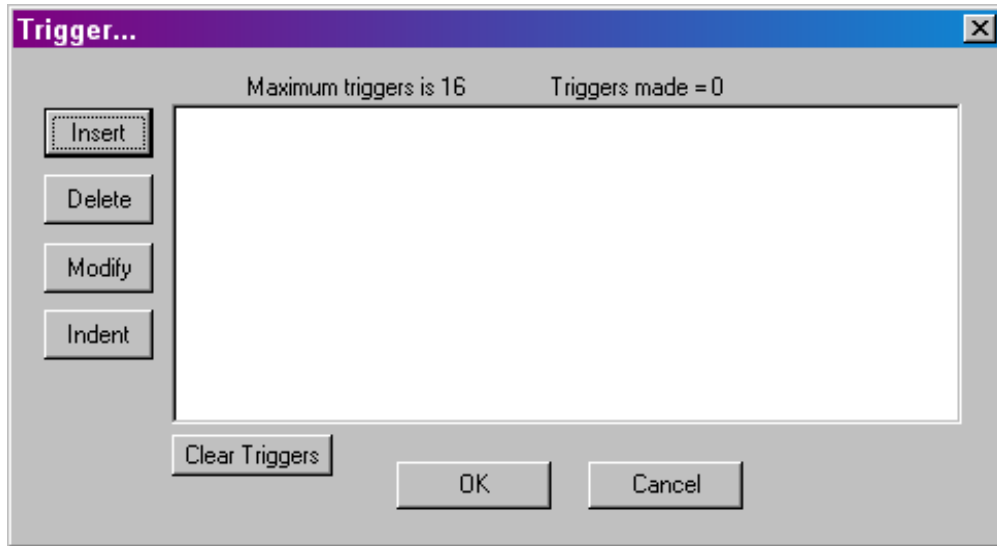

Figure 11 — The Trigger Display

Clicking the **Insert** button in **Figure 11** will cause the following to appear. **NOTE:** The number base in which the values are displayed — hexadecimal or decimal — can be chosen under the **View Menu**. In **Figure 12**, the values are shown in hexadecimal.

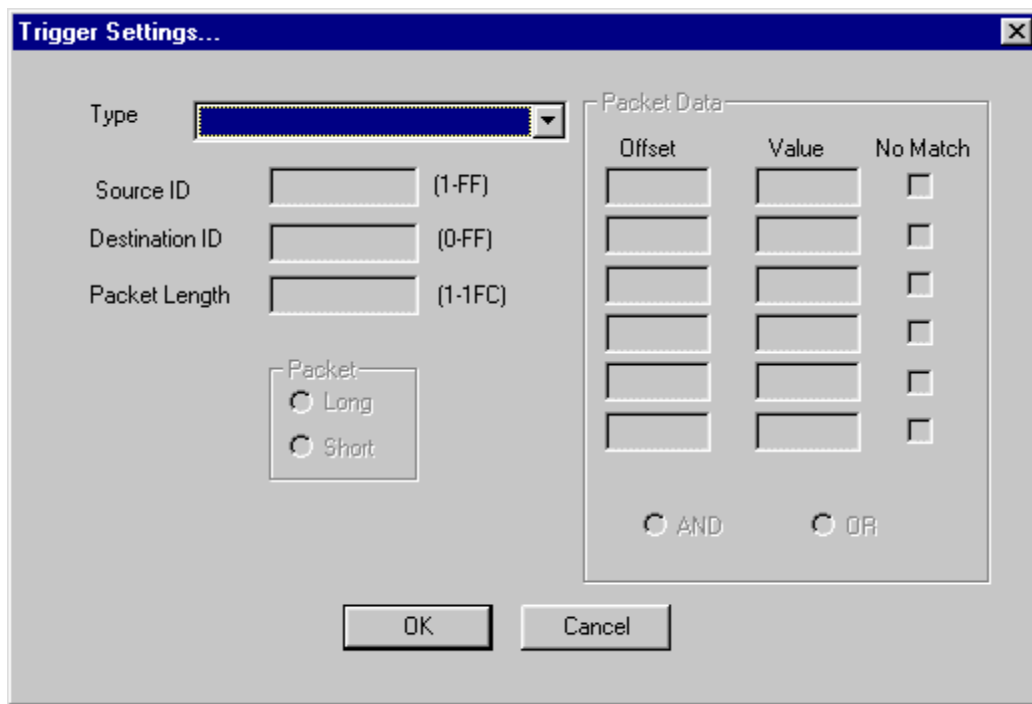

Figure 11 — The Trigger Menu

The **Type** selection displayed in **Figure 13** below provides a drop-down list of 6 frames from which to choose. Two of the types — ITT and FBE — have only one setting to be configured: Destination ID. Three types — ACK, NAK and ERR — have no settings at all. Packet settings are only available if Packet (PAC) is the chosen frame type.

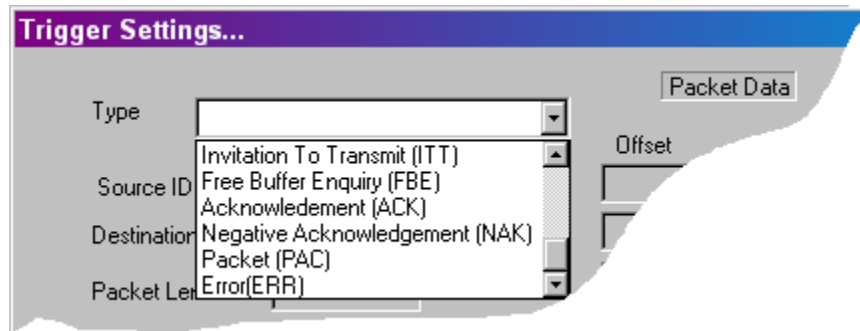

Figure 11 — Frame Types Settable in Trigger Settings Window

In **Figure 14**, buttons on the left side of the window affect *individual lines* of the display. Each line specifies only *one frame*, but a frame specification may contain *more than one trigger*. A trigger is *any functional element* in a line. For example, the 3rd frame in **Figure 14** contains 3 triggers: PAC, SID and DID. As triggers are set, their number is reported by **Triggers made = [#]** above the detail display. Up to 16 triggers may be set.

The **Insert** button allows the user to specify a trigger. The **Delete** and **Modify** buttons affect *only* the selected (highlighted) frame specification. The **Indent** button, does more than simply indenting the selected frame. The **Indent** function *binds* the indented frame to the one immediately preceding so that the two frames must occur *adjacent in time* for the trigger combination to work. Example: The 5th specification “FBE DID=3” in **Figure 14** must occur *immediately* before the following ACK — or no triggering occurs. Once *the entire set* of specified triggers have occurred, **ARCNET Analyzer** is triggered. If the entire trigger specification is not satisfied (a trigger is missing or indented frames are not adjacent in time) then **ARCNET Analyzer** will not trigger.

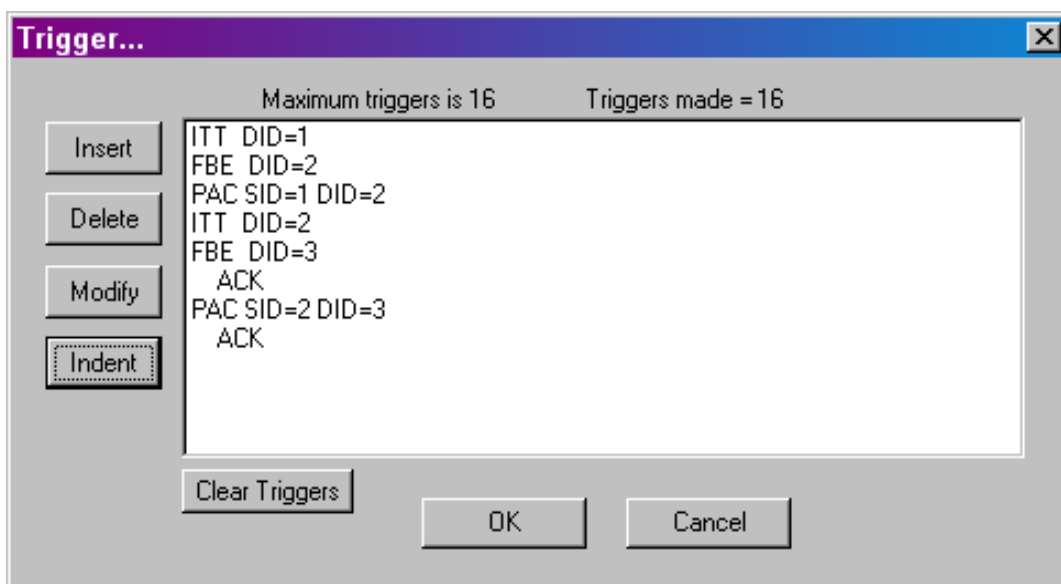

Figure 11 — Trigger Screen Features

1.1.1. Specifying Triggers in a Packet Frame

The **PAC** frame type allows several triggers in the frame specification. In the example depicted in **Figure 15**: the **Source ID** is 1, the **Destination ID** is 2, the **Packet Length** is 150H bytes and the **Long Packet** button has been selected. Under the **Packet Data** section of the display, 2 *data value* triggers have been defined by their **Offset/Value** parameters: (0/12) and (144/A4). Just this one frame specification will result in the use of 7 *triggers*: PAC; SID; DID; LEN; (0/12); (144/A4) plus one for the long packet.

Options also exist to *logically qualify* packet data in which the stipulated data values are subjected to AND/OR and TRUE/FALSE tests. When checked, each **No Match** option box enables triggering when its associated value does NOT find a match in the data stream. In the example of **Figure 15**, the 144/A4 specification will enable a trigger whenever the data byte offset by 144 contains ANY value EXCEPT A4. Because the **AND** radio button has been selected, **ARCNET Analyzer** will trigger ONLY when its examination of the data stream finds that data specification 0/12 is *matched* AND specification 144/A4 is *not matched*. The default condition (where no logic options are specified) provides that ALL data specifications must MATCH.

Clicking the **Long Packet** button was redundant in this example. The **Long** and **Short** buttons should be used to specify packet lengths in those cases where precise packet length is unimportant in the specification.

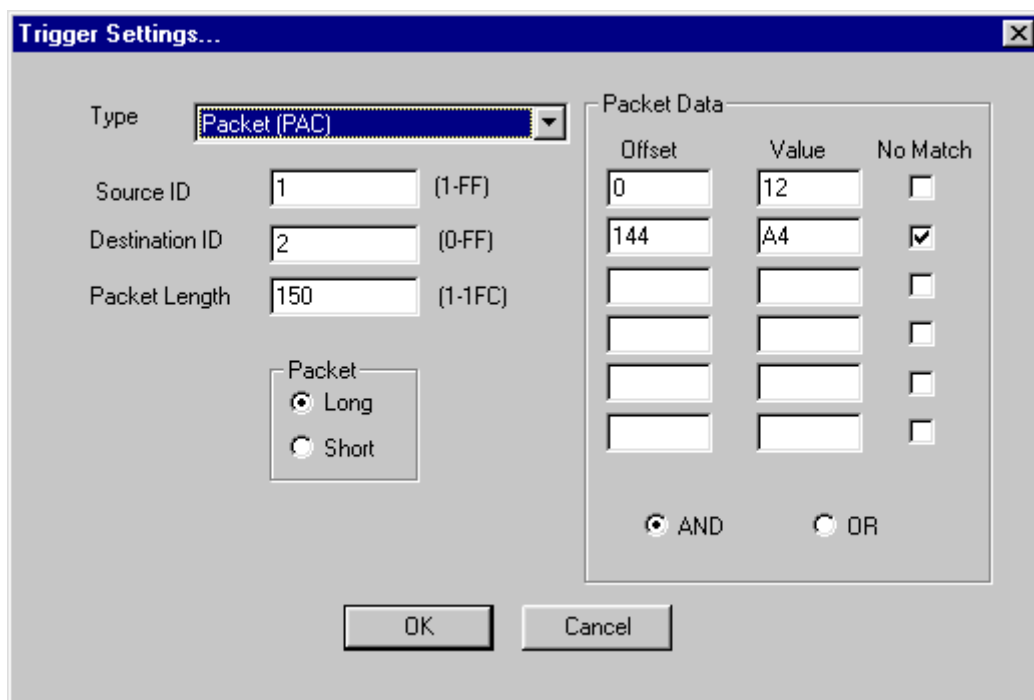

Figure 11 — Specifying Triggers in a Packet Frame

The trigger specification that results from the above settings is depicted in **Figure 16** on the next page.

Note in **Figure 16** that a long packet *counts as a trigger*. This is true *whether or not* the **Long Packet** button is selected. This happens because long-packet offsets are calculated *differently* from those used in short packets. If no distinction were made between short and long packets, offsets would be correct *only* for short packets. The existence of *exception packets* (of lengths between short and long packets) create the need to adjust those offsets which point to data values in the 257–507 byte range, otherwise they could not be properly located. For a further discussion of these concepts, see the **ARCNET Tutorial** which accompanies this manual.

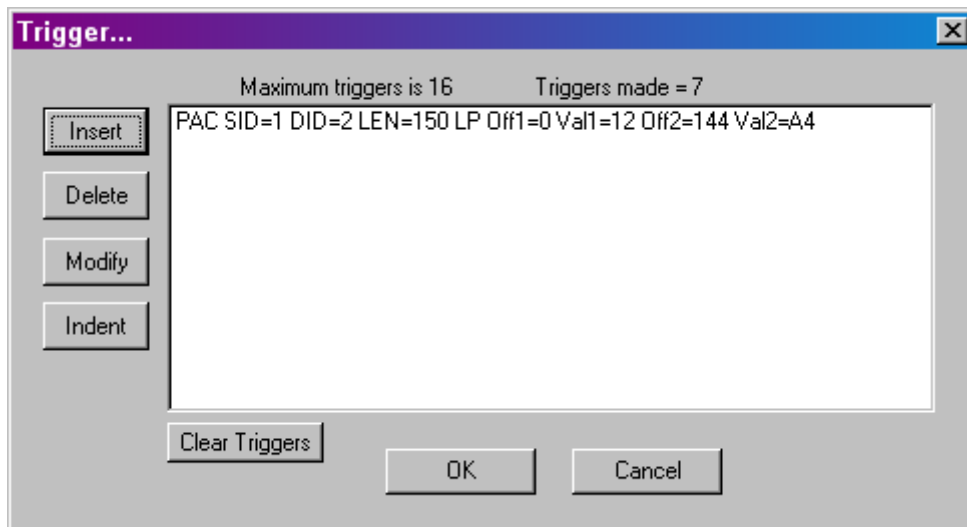

Figure 11 — A Packet Trigger Specification

Using ARCNET Analyzer

Starting ARCNET Analyzer

Select **ARCNET Analyzer** from the Windows **Start | Programs** menu structure. The **Main Display** will appear. Verify the USB Module is properly powered and connected to the field bus and host computer before proceeding. An option allows the program to launch from DOS and begin capturing data automatically as described in **Section 8.10**.

LED Indicators

ARCNET Analyzer is provided with six LEDs which serve to indicate various states of operation. The LEDs report on the status of **power** and **data**.

Power LEDs

These LEDs are adjacent to the 5 VDC Jack and indicate the following:

<u>Label</u>	<u>Function</u>	<u>Colour</u>	<u>Description</u>
PWR	Power	Green	Glows to indicate the 5-volt supply is functioning properly.
RST	Reset	Red	Glows to indicate an abnormality in the 5-volt supply.

Data LEDs

These LEDs are adjacent to the TRIG Jack and indicate the following:

<u>Label</u>	<u>Function</u>	<u>Colour</u>	<u>Description</u>
RDY	Ready	Yellow	Glows to indicate ARCNET Analyzer is ready to acquire data. This LED will not glow until Data Rate , Port and Filter settings have been downloaded to RAM in the USB Module. Trigger parameters have no affect on this LED.
ARM	Armed	Yellow	Glows after the Start button has been clicked to indicate <i>a trigger has been specified but has not yet been received</i> . Data acquisition can be accomplished without the use of a trigger, in which case this LED will never glow.
ACQ	Acquiring	Green	Glows to indicate data is being acquired — in either <i>triggered</i> or <i>untriggered</i> operation. If triggers are in use, this LED will glow <i>when a trigger is received</i> . If triggers are not in use, the LED will glow <i>when the Start button is activated</i> . In either case, this LED will stay lit until data capture has stopped.
ERR	Error	Red	Glows to indicate an internal hardware error. The USB Module requires service.

Adjusting Signal Sensitivity

The USB Module has devices for adjusting the sensitivity of three inputs — though deviation from factory settings is rarely justified. The user should confirm that changes are needed before attempting such adjustment. The locations of these devices are illustrated in **Figure 17** below. Trigger input circuitry is discussed on the next page.

Coaxial Signal Receiver Sensitivity — R92

By default, all three pins of jumper block JP12 are left open — resulting in the coaxial receiver sensitivity set by the factory. If pins 1-2 of JP12 are jumpered (shorted), the receiver will respond to the weakest signal possible. If pins 2-3 are jumpered, the sensitivity of the received signal can be adjusted with R92.

EIA-485 Signal Receiver Sensitivity — R50

By default, all three pins of jumper block JP3 are left open — resulting in the EIA-485 receiver sensitivity set by the factory. If pins 1-2 of JP3 are jumpered, the receiver will respond to the weakest signal possible. If pins 2-3 are jumpered, the sensitivity of the received signal can be adjusted with R50.

Isolated Trigger Sensitivity — R84

An external trigger may be applied to an opto-isolator via pins 1-2 of the TRIG Jack. The typical threshold value of 5 volts can be varied from 5 to 24 volts by adjusting R84.

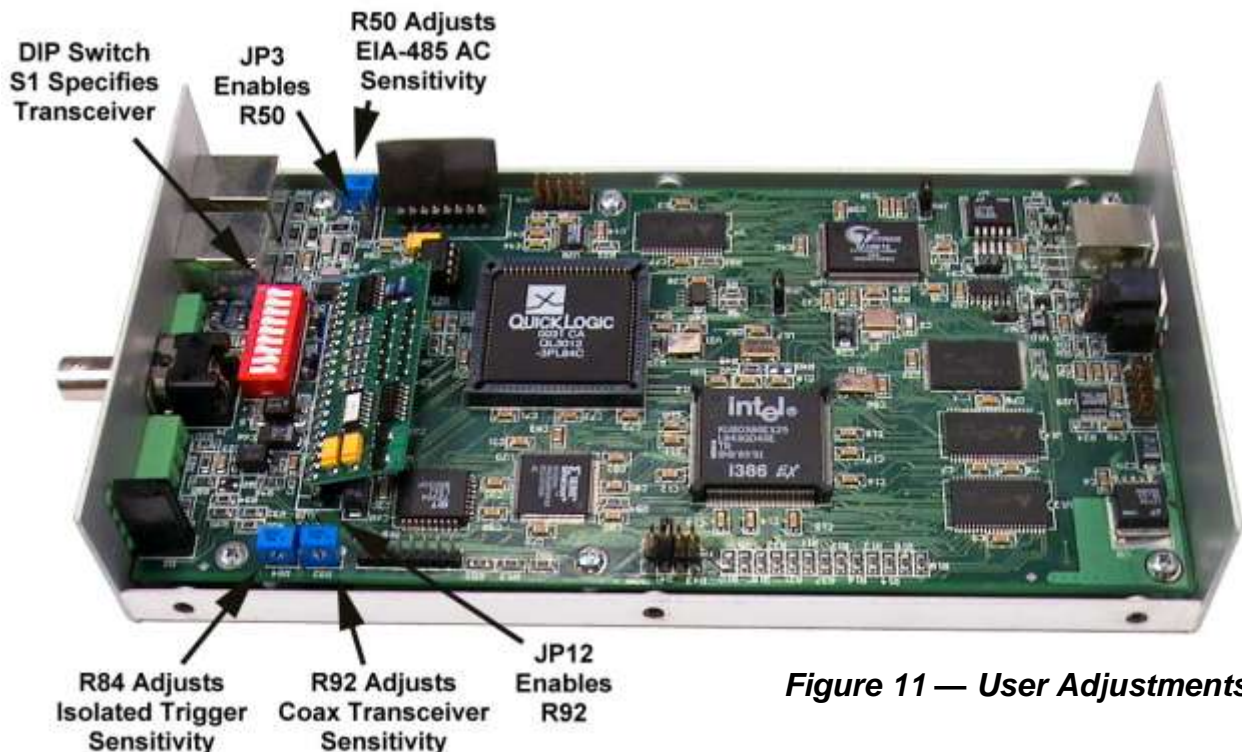

Figure 11 — User Adjustments

Figure 18 illustrates the circuitry for trigger inputs applied to J3. Isolated trigger inputs are applied to pins 1-2 and non-isolated trigger inputs to pins 3-4.

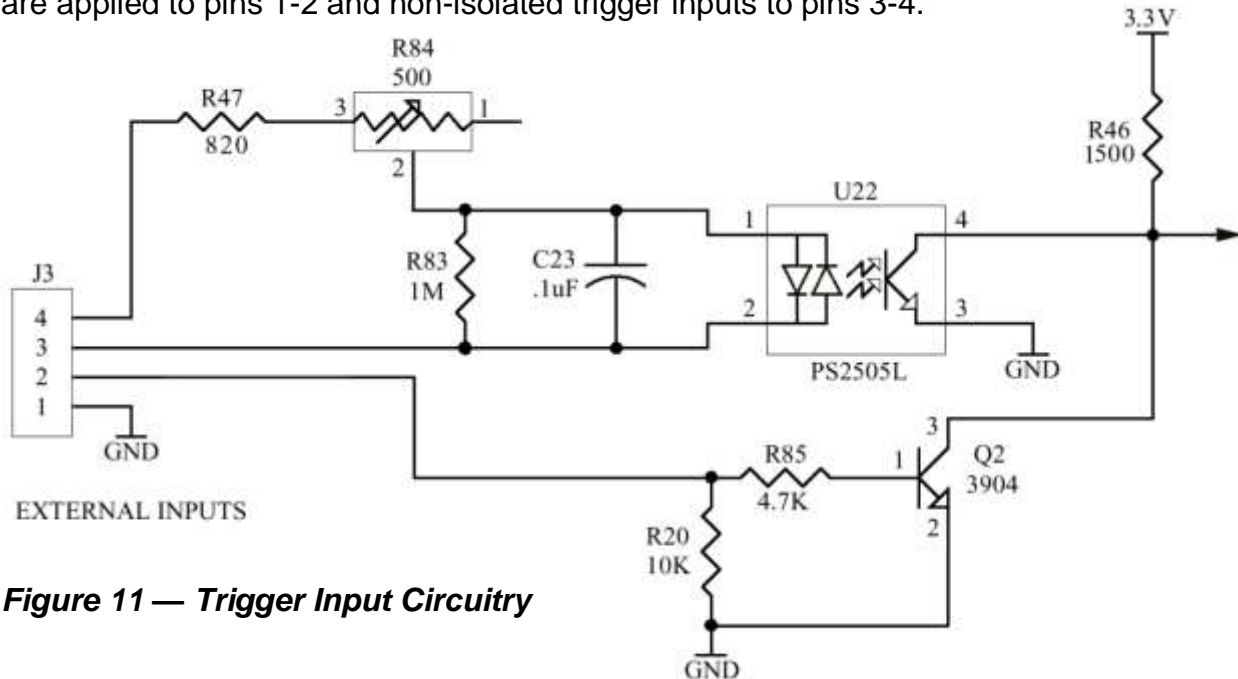

Figure 11 — Trigger Input Circuitry

The Main Display

Display Modes

During data acquisition, the user can toggle between two display modes at will — **Normal** and **Scroll** — described below.

Normal Mode

Normal Mode is invoked via the **Options / Normal Mode** menu selection. In this mode, initial data will be displayed while additional data capture proceeds in the background. After data acquisition is ended, final captured data will be displayed and the **Analyzer State** will report “Capture Complete.”

Scroll Mode

Scroll Mode is invoked via the **Options / Scroll Mode** menu selection. When this mode is invoked, an inactive **Pause** button will appear beneath the display window. Once data acquisition is started, the display will scroll to show real-time data as it is captured. The **Pause** button will also become available for use. Clicking the button will pause the *display* as data capture continues in the background. Another click of the button (now labelled **Resume**) will display the data that is currently being captured. It does not display data from where it paused. After data acquisition ends, the **Pause** function (if active) will disengage, final captured data will be displayed and the **Analyzer State** will report “Capture Complete.”

The Data Window

Various useful information is presented in the **Data Window** as indicated in **Figure 19**.

Time Stamp(s) — This reports *when* each individual frame was received.

Absolute — If this option is chosen, the **Time Stamp** represents the time elapsed since reception of the first message. (The **Relative** option is unavailable in this release of *ARCNET Analyzer*.) The **Time Stamp** interval varies with the **Data Rate** as shown in **Section 8.8**.

Trigger column — An *asterisk* marks the trigger frame. If a trigger specification consists of multiple frames, the asterisk marks the *final* frame of the sequence.

Type — The frame types reported in this column are discussed in **Section 8.3**

SID — Source Identifier indicates the transmitting node.

DID — Destination Identifier indicates the receiving node.

Length — This reports the Length of data in an ARCNET data packet.

SC — System Codes are reported in this column. **Section 6.4.3** discusses how system codes are treated by *ARCNET Analyzer*.

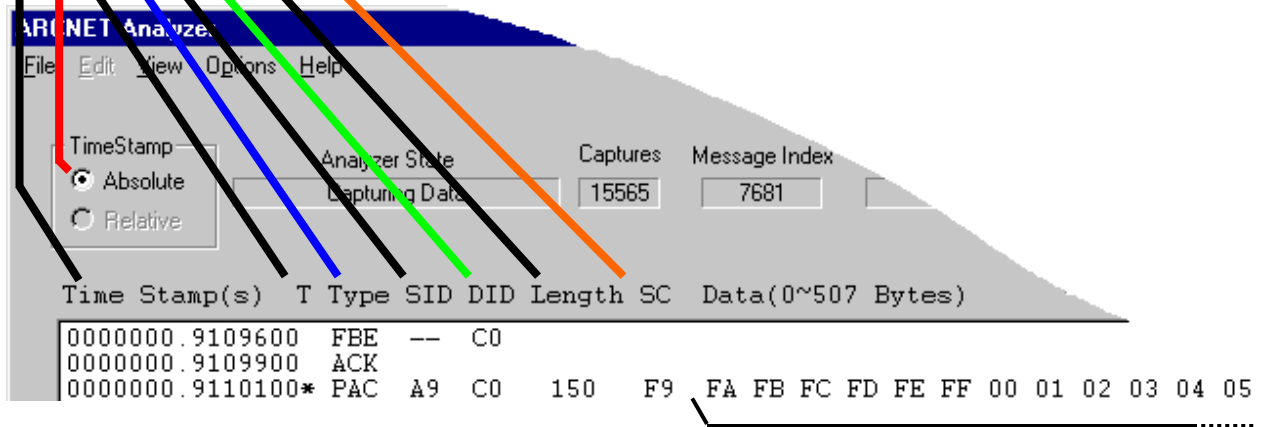

Figure 11 — Features of the Data Window

It is usually the case that the length of a data packet is so great that only the first dozen or so bytes can be shown and the remainder cannot be presented on the **Main Display**. To view the entire packet, select (highlight) the packet line in the **Main Display** then *double-click* it to open a **Details** window such as the one pictured in **Figure 20** on the next page.

Captured Packet Detail

The vertical scroll bar present in **Figure 20** below allows the examination of all packet contents — both as **Raw Data** on the left and as **ASCII Data** on the right. The window is mostly self-explanatory in the way that it displays the **Source ID**, **Destination ID**, and **Packet Length**. The **System Code** field is discussed below and is further illustrated in **Figure 21** and **Figure 22** on the next page.

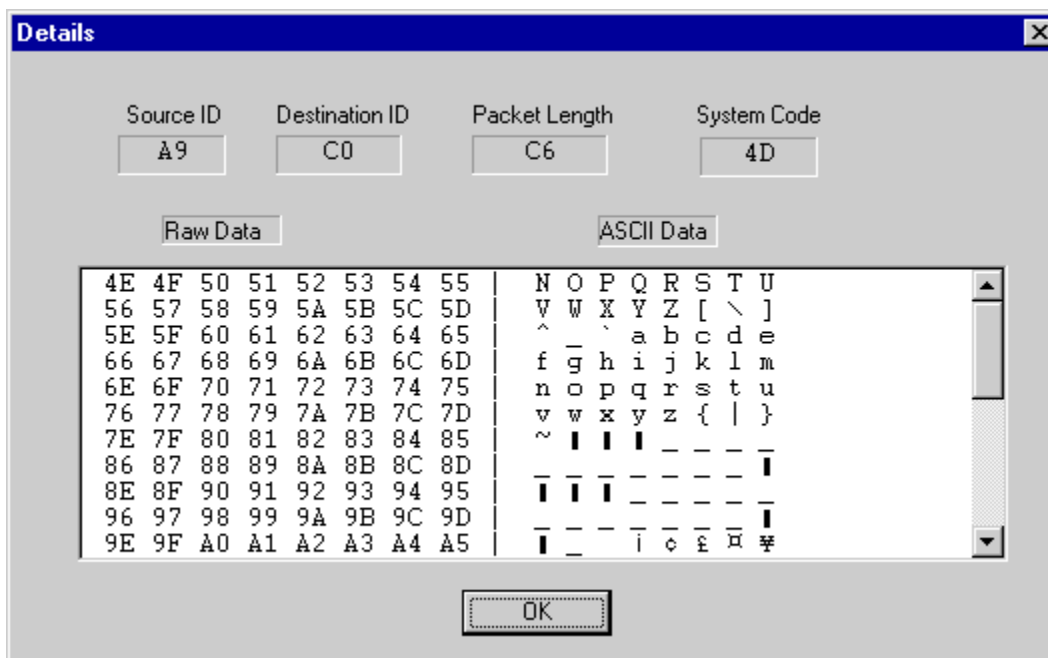

Figure 11 — Captured Packet Detail

In some ARCNET traffic, a **System Code** is used. In other cases, it is not. Within a given PAC frame, **ARCNET Analyzer** can treat the data as having a **System Code** or not having one. As explained below, this depends on whether or not the **Options | No System Code** item in the drop-down menu has been checked.

On the next page, examine **Figure 21** carefully. This example shows that the first byte (4D) after the **Data Length Code** is recognized as a **System Code** and reported as such in the **System Code** field of the Details window. The next byte (4E) is reported as the first data byte under the Raw Data display. This situation exists because the **No System Code** option has *not* been checked.

Now consider **Figure 22** which displays the same frame, but shows that the **No System Code** option *is now checked*. When engaged, this option causes **ARCNET Analyzer** to treat the first byte following the **Data Length Code** as a *data* byte, not a system code. As a result, the **System Code** field of the Details window is empty and deactivated. The first byte (4D) is *no longer recognized* as a **System Code**, but is now reported as the first byte of *data* under the Raw Data display.

Figure 11 — System Code Recognized

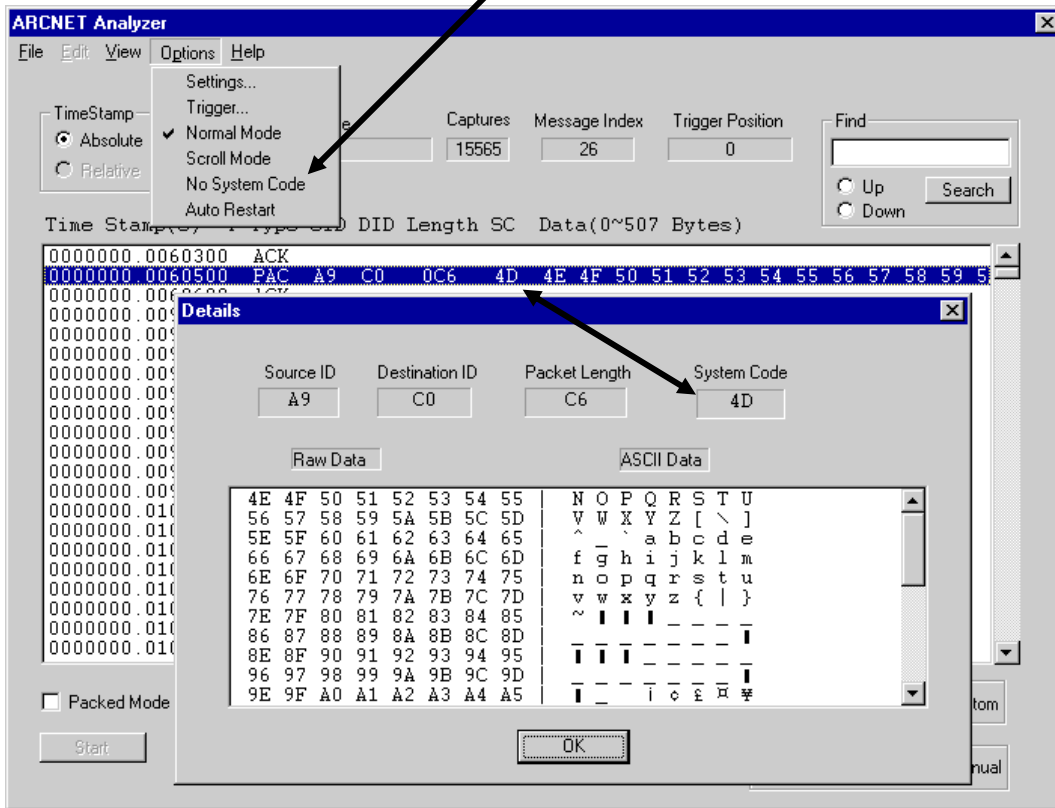
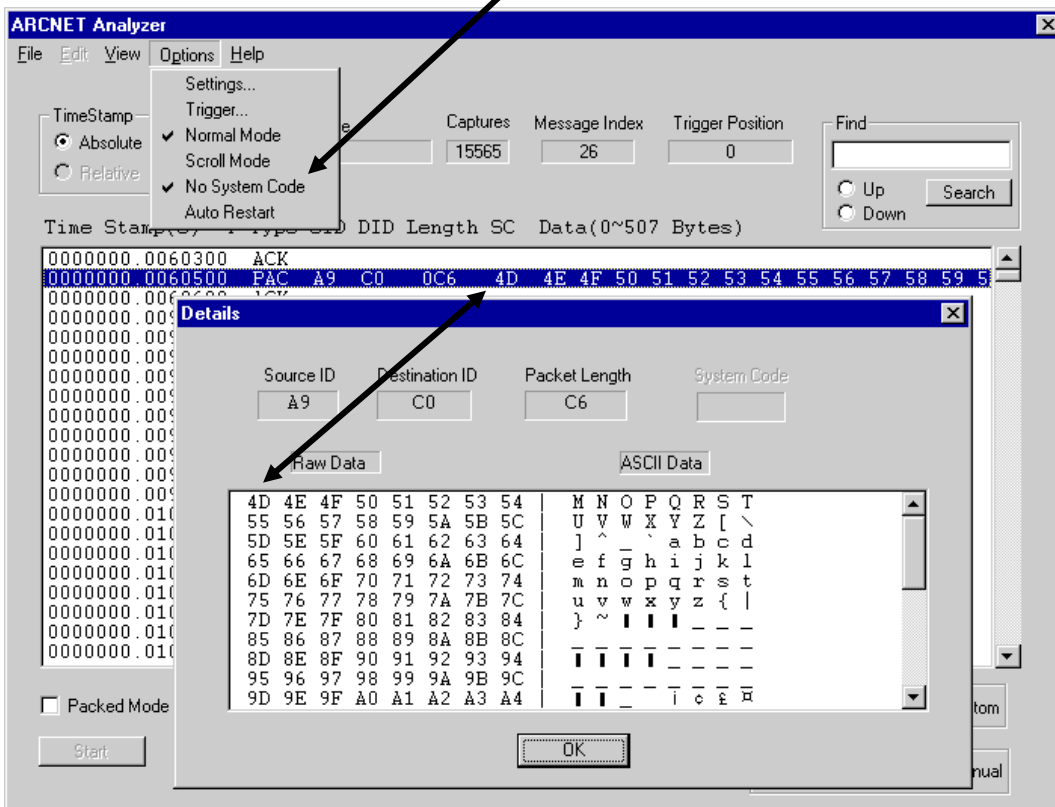

Figure 11 — No System Code Option Activated



Operating Modes

Auto Restart Mode

If the user wishes to run a data capture session repeatedly, **Auto Restart** can be invoked from the **Options / Auto Restart** menu selection. In this mode, data capture proceeds until the Capture Buffer is full. At that point, the acquired data is cleared and a new data capture session is begun.

Packed Mode

When traffic conditions are heavy, data storage may become an important issue. Checking **Packed Mode** will compress data for more efficient data storage. Another useful feature of this mode is its ability to measure the duration of an error frame (ERR) which could be due to a reconfiguration burst or electrical noise. Comparing this value with the known length of a RECON burst (listed in **Section 8.8**), it is possible to determine whether the ERR was due to noise or a RECON.



Capturing Data

Clicking on the **Start** button in the lower left area of the **Main Display** initiates a capture session. However, the following features should be taken into consideration.

1.1.1. Capture Buffer

The **ARCNET Analyzer** USB Module contains a RAM buffer 512 kB in size to store messages captured from the ARCNET bus. By storing messages in an onboard buffer, the processing time for each message is minimized. Most other ARCNET analyzers use a smaller RAM buffer of only a few hundred messages. To store more than this number, other bus analyzers log the data to a text file and allow the user to analyze it off-line. However, accessing the hard disk to store data into a text file is considerably slower than accessing RAM. This can lead to message loss, especially at high bus loads, and the user fails to observe all ARCNET bus activity. **ARCNET Analyzer** is different in that it uses an onboard buffer with data transfer to the host *when the USB Module's 386 CPU is not busy capturing data*. Therefore, the user can review much more of the ARCNET bus activity off-line using **ARCNET Analyzer**, without the risk of losing data because of message processing overhead.

Trigger Position and the Capture Buffer

How the Capture Buffer fills depends on three things:

- 1) when a **Trigger** occurs
- 2) if the **Stop** button is clicked
- 3) which trigger position is selected

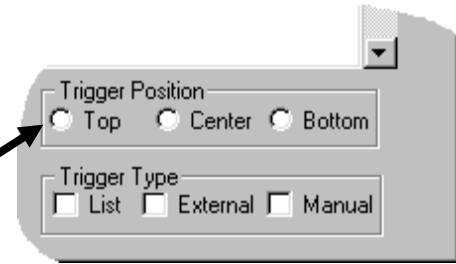

If the **Top Position** is chosen for the trigger, the Capture Buffer does not begin to fill until a **Trigger** occurs. If allowed to fill without interruption, the buffer will fill completely as illustrated in Chart A of **Figure 23**. Data acquisition then terminates automatically. If the **Stop** button is clicked, the buffer partially fills as seen in Chart B of **Figure 23**.



Figure 23 — Top Triggering

If the **Bottom Position** is chosen, the Capture Buffer starts filling on a click of the **Start** button. Two events will end data acquisition — a **Trigger** or a click of the **Stop** button. If not interrupted, the buffer will fill completely as illustrated in **Figure 24** — where capture ends with either a **Trigger** (as in Chart A) or a click of the **Stop** button (as in Chart B). Although the buffer overflows before termination occurs, a *full* buffer of *current* data is maintained because data *wraps* back to the beginning as new data replaces old. On the other hand, either termination event could occur before the buffer has filled, resulting in a partial fill as shown in **Figure 24**, Charts C and D.

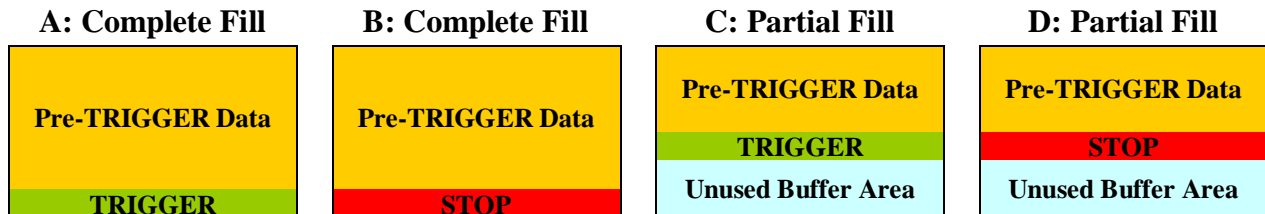

Figure 23 — Bottom Triggering

If triggering is set to **Centre Position**, the Capture Buffer will start filling at the click of the **Start** button. The intent with centre positioning is to achieve a perfect data fill (as in **Figure 25**, Chart A), but certain factors may cause the trigger to be uncentered.

The perfect fill will *only* result when data acquisition terminates *automatically* and if the buffer has filled to *at least the halfway point* when triggering occurs. If the buffer has filled beyond the halfway mark before triggering occurs (as in **Figure 25**, Chart B), data capture will not end when the buffer limit is reached. Instead, data will *wrap* back to the beginning of the buffer with the *earliest* portion of the Pre-Trigger Data being replaced with the *latest* portion of the Post-Trigger Data until the trigger has been positioned in the *logical centre* of the buffer. If the trigger arrives prematurely (as in **Figure 25**, Chart C) with less than half the buffer holding data, then *imperfect* centring will result as data acquisition continues until the buffer limit is reached.

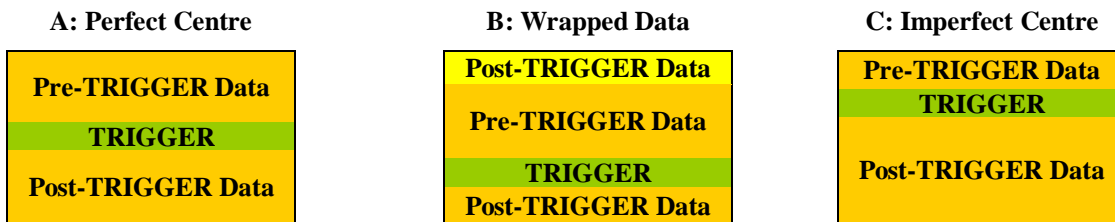

Figure 23 — Centre Triggering with Automatic Termination of Data Capture

If data acquisition is interrupted with a click of the **Stop** button, the result will be an *uncentered* trigger. This can happen before a trigger occurs (as in **Figure 26**, Chart A) or after a trigger occurs (as in **Figure 26**, Chart B). In either case, the actual amount of data captured will vary according to *when* the **Stop** button is clicked and *if and when* the **Trigger** arrives.



Figure 24 — Centre Triggering with Manual Termination of Data Capture

Analyzer States

Initially **ARCNET Analyzer** will need to be configured. Until that is done, it will have no operational state.

After configuration, the following six states of operation are possible.

Idle

After **ARCNET Analyzer** has been configured, it will assume the **Idle** state until data acquisition is begun by clicking the **Start** button. Once a capture session has ended and the data buffer cleared, the **Idle** state will again be invoked.

Capturing Data

Data acquisition begins as a result of clicking the **Start** button. **ARCNET Analyzer** will continue capturing data until either the **Stop** button is clicked or the data buffer is full.

NOTE: In **Scroll Mode**, clicking the **Pause** button will *not* affect data capture; it merely freezes the display while data capture continues in the background. Continued data acquisition is confirmed by the steadily increasing number of “Captures” despite the fact that the display is “paused.”

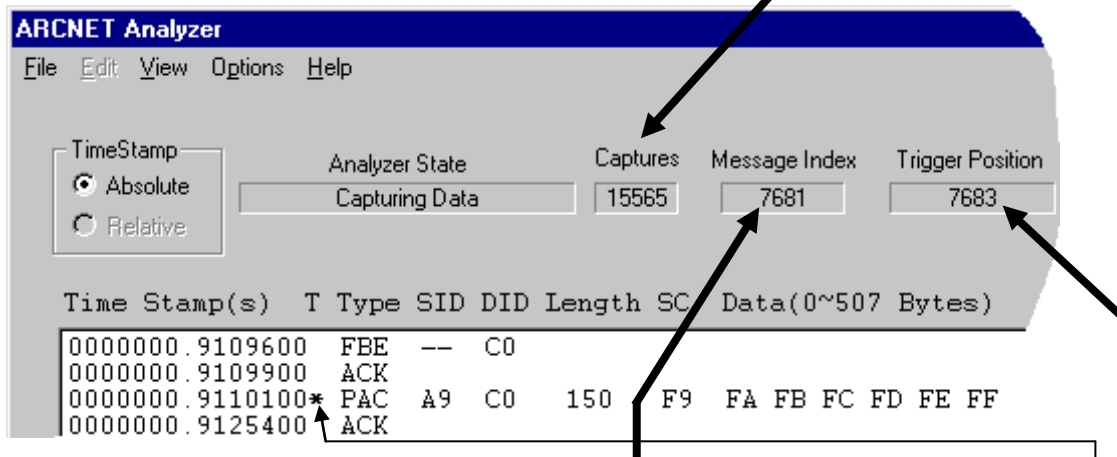

The top line of the current window is the **Message Index** which indicates how many frames separate the *current window* from the beginning of the buffer. The **Message Index** advances each time the display scrolls.

Waiting for Trigger

This state exists *only* if triggers are in use. If a trigger has been defined and a trigger type specified, then clicking the **Start** button will begin data capture and invoke the **Waiting for Trigger** state. When the trigger occurs, an asterisk identifies its line position. Also just above the data display, the **Trigger Position** is reported. In the example shown above, the **Trigger Position** (7683) is two lines below the **Message Index** (7681).

Trigger Found, Capturing Data

How data is treated in response to a trigger, depends on the Trigger Position selected. If **Top Position** is chosen, the top of the Capture Buffer stores the trigger frame and data capture continues until the buffer is full. When **Centre Position** is selected, the buffer has captured data before the trigger event and continues to do so until the end of the buffer is reached. If **Bottom Position** is in use, data acquisition will *end* with the arrival of the trigger — so the **Trigger Found, Capturing Data** state will not occur.

Capture Stopped

Clicking the **Stop** button will end data capture and the session. Before acquiring more data, the Capture Buffer must be *cleared* and a new data capture session begun. To exit from the **Capture Stopped** state, click the **Clear** button — causing the buffer to empty and **ARCNET Analyzer** to revert to the **Idle** state. Before clearing the buffer, captured data can be stored to disk for later study by clicking the **File | Save** option.

Capture Complete

After the data buffer is full or the **Stop** button has been clicked, the **Capture Complete** state will result. Any further data capture will require a new session of data acquisition. The **Capture Complete** state will end only after the **Clear** button has been clicked causing the data buffer to be emptied and the program to revert to the **Idle** state.

Ending and Saving a Capture Session

Stopping Capture

Data capture will terminate automatically in accordance with the trigger settings in use and the reception of the specified trigger. Otherwise, clicking the **Stop** button will end a capture session.

Saving Captured Data

The user can save captured data by selecting the **File / Save** drop-down menu option or by pressing the Ctrl + S hotkey combination. (The **Save As** option is unavailable in this release of **ARCNET Analyzer**.)

The dialogue box will appear, letting the user save captured data as a file. The default format (***.aad**) permits re-opening the file in **ARCNET Analyzer** at a later stage. An option allows the user to save the data as a text file in Comma Separated Variable format (***.csv**). A CSV file cannot be re-opened by **ARCNET Analyzer**, but can be read by various applications. CSV files identify the data rate, port type, filters in operation, and whether triggered or non triggered mode is used. Saved messages include Message Index, Time Stamp, Trigger, Type, SID, DID, Length, System Code and Data (0-507 bytes). Since CSV files are often viewed with Microsoft[®] Excel, data is packed four bytes per cell to allow 508 data bytes to fit within the 255-column limit of Excel.

Clearing the Captured Data

Clicking the **Clear** button, will reset the data buffer and clear the capture screen.

Search Function

A useful feature of the **Main Display** is the **Find** function, shown in **Figure 28** below. By entering any character or character string into the search window then clicking the **Search** button, **ARCNET Analyzer** will find the next occurrence of the search string within the captured data. The search direction can be specified by selecting **Up** or **Down** and it is not case sensitive.



Figure 24 — Search Function

Service

Warranty

Contemporary Controls (CC) warrants its product to the original purchaser for two years from the product's shipping date. If a CC product fails to operate in compliance with its specification during this period, CC will, at its option, repair or replace the product at no charge. The customer is, however, responsible for shipping the product; CC assumes no responsibility for the product until it is received. This warranty does not cover repair of products that have been damaged by abuse, accident, disaster, misuse, or incorrect installation.

CC's limited warranty covers products only as delivered. User modification may void the warranty if the product is damaged during installation of the modifications, in which case this warranty does not cover repair or replacement.

This warranty in no way warrants suitability of the product for any specific application.

IN NO EVENT WILL CC BE LIABLE FOR ANY DAMAGES INCLUDING LOST PROFITS, LOST SAVINGS, OR OTHER INCIDENTAL OR CONSEQUENTIAL DAMAGES ARISING OUT OF THE USE OR INABILITY TO USE THE PRODUCT EVEN IF CC HAS BEEN ADVISED OF THE POSSIBILITY OF SUCH DAMAGES, OR FOR ANY CLAIM BY ANY PARTY OTHER THAN THE PURCHASER.

THE ABOVE WARRANTY IS IN LIEU OF ANY AND ALL OTHER WARRANTIES, EXPRESSED OR IMPLIED OR STATUTORY, INCLUDING THE WARRANTIES OF MERCHANTABILITY, FITNESS FOR PARTICULAR PURPOSE OR USE, TITLE AND NONINFRINGEMENT.

Repair or replacement as provided above shall be the purchaser's sole and exclusive remedy and CC's exclusive liability for any breach of warranty.

Technical Support

Technical support is available each weekday (except holidays) during the office hours listed below. Outside these hours, voice-mail messages can be left in our mailbox after contacting the main phone number. Requests can also be submitted by fax or by e-mail to the numbers listed below, but please leave a detailed description of the problem. We will contact you the next business day by the method requested by the customer. If the problem cannot be resolved by technical support, the customer will be given an RMA number in order that the product may be returned to CC for repair.

Support Option	Contemporary Controls (USA)	Contemporary Controls Ltd (UK)
Office Hours	8:00 a.m. — 5:00 p.m. Central time	8:00 a.m. — 5:00 p.m. United Kingdom time
Voice	+1-630-963-7070	+44 (0)24 7641 3786
Fax	+1-630-963-0109	+44 (0)24 7641 3923
Email	techsupport@ccontrols.com	support@ccontrols.co.uk
Web Site	www.ccontrols.com	www.ccontrols.co.uk

Warranty Repair

Products under warranty that were not subjected to misuse or abuse will be repaired at no charge to the customer. The customer, however, pays for shipping the product back to CC while CC pays for the return shipment to the customer. CC normally ships ground. International shipments may take longer. If the product has been determined to be misused or abused, CC will provide the customer with a quotation for repair. No work will be done without customer approval.

Non-Warranty Repair

CC provides a repair service for all its products. Repair charges are based upon a fixed fee basis depending upon the complexity of the product. Therefore, Customer Service can provide a quotation on the repair cost at the time a Returned Material Authorization (RMA) is requested. Customers pay the cost of shipping the defective product to CC and will be invoiced for the return shipment to their facility. No repair will be performed without customer approval. If a product is determined to be unrepairable, the customer will be asked if the product can be replaced with a refurbished product (assuming one is available). Under no circumstances will CC replace a defective product without customer approval. Allow ten working days for repairs.

Returning Products for Repair

To schedule service for a product, please call CC Customer Service support directly at +1-630-963-7070 (U.S.) or +44 (0)24 7641 3786 (U.K.). Have the product model and serial number available, along with a description of the problem. A Customer Service representative will record the appropriate information and issue, via fax, an RMA number—a code number by which we track the product while it is being processed. Once you have received the RMA number, follow the instructions of the Customer Service support representative and return the product to us, freight prepaid, with the RMA number clearly marked on the exterior of the package. If possible, reuse the original shipping containers and packaging. In any event, be sure you follow good ESD-control practices when handling the product, and ensure that antistatic bags and packing materials with adequate padding and shock-absorbing properties are used. CC is not responsible for any damage incurred from improper packaging. Shipments should be insured for your protection.

Ship the product, freight prepaid, to the location from which it was purchased:

Contemporary Control Systems, Inc.
2431 Curtiss Street
Downers Grove, IL 60515
U.S.A.

Contemporary Controls Ltd
Sovereign Court Two
University of Warwick Science Park
Sir William Lyons Rd.
Coventry CV4 7EZ
U.K.

Appendices

Declaration of Conformity

Applied Council Directives:

Low Voltage Directive 2006/95/EC

General Product Safety Directive 2001/95/EC

Electromagnetic Compatibility Directive, 2004/108/EC

Restriction of Hazardous Substances Directive 2002/95/EC

Waste Electrical and Electronic Equipment Directive 2002/96/EC

Standard to which Conformity is Declared

EN 55022:1998 + A1:2000 + A2:2003, Class A, Limits and Methods of Measurement of Radio Disturbance Characteristics of Information Technology Equipment

EN 55024:1998 + A1:2001 + A2:2003, Information Technology Equipment — Immunity Characteristics — Limits and Methods of Measurement

Manufacturer:

Contemporary Control Systems, Inc.
2431 Curtiss Street
Downers Grove, IL 60515 USA

Authorized Representative:

Contemporary Controls Ltd
Sovereign Court Two
University of Warwick Science Park
Sir William Lyons Road
Coventry CV4 7EZ
UNITED KINGDOM

Removing ARCNET Analyzer from the Host Computer

ARCNET Analyzer can be removed from the host computer using standard Windows tools: Select **Add/Remove Programs** from the **Control Panel**. From the list of programs choose **ARCNET Analyzer**, then press the **Add/Remove** button. Once Windows completes its process, *ARCNET Analyzer* has been removed.

Frame Types

Frame Type	Description
ITT	Invitation to Transmit — ITT is the token which allows the node holding it to transmit data. If the node has nothing to transmit, it passes the token to the node having the next highest address. The node which will receive the token is identified by the frame element DID (Destination Identifier — also called “NID” in some discussions). Token-passing proceeds until all nodes have participated. Each node address must be unique in the range 1–255.
FBE	Free Buffer Inquiry — If the node in possession of the token needs to transmit, it queries the destination node with an FBE which determines if the destination node is able to accept the transmission. As with an ITT , the destination node is identified with the DID frame element.
ACK	Acknowledgement — If the destination node is <i>capable</i> of receiving data, it responds to an FBE with an ACK . If the destination node correctly receives the data, it responds with another ACK . These ACKs are not directed to the source node, so no DID appears in the ACK response.
NAK	Negative Acknowledgement — If the destination node is <i>incapable</i> of receiving a transmission, it responds to an FBE with a NAK . As with ACK , the response is not directed to the inquiring node, so DID is not used. NAK is <i>not used</i> to report a failure to receive data; instead, the <i>absence of an ACK</i> indicates the failure.
PAC	Packet — If ACK is the response to an FBE , a PAC (data packet) is transmitted. Packet length ranges from 0–507 bytes and is indicated by the element LEN .
ERR	Error — Unlike true frame types used for normal ARCNET messaging, ERR indicates an error condition which is most likely a <i>RECON</i> burst. Often the error involves a <i>broken message</i> (symbolized by BRK) caused by either a <i>RECON</i> or noise, in which case a BRK will precede the ERR . In Packed Mode , the ERR length is measured and reported in the data display. Using the table of Section 8.8 , the ERR frame length can be used to distinguish between noise and <i>RECONs</i> .

How Frames and Frame Elements Count as Triggers

NOTE: In the table below, **DID** and **SID** are standard ARCNET frame elements. Many more elements which **ARCNET Analyzer** does *not* use as triggers are discussed in the **ARCNET Tutorial** which accompanies this manual. **LEN** (length), is not a standard element. It is a trigger parameter used by **ARCNET Analyzer**. If **LEN** exceeds 256 bytes, *an additional trigger is used* in informing **ARCNET Analyzer** that a long packet is present and therefore the offset must be calculated accordingly.

Frame Type	+ Frame Element	= Trigger Count
ITT	DID	2
FBE	DID	2
ACK	None	1
NAK	None	1
PAC	All optional : SID, DID, LEN, and up to 6 offset/value parameter pairs	1–11
ERR	None	1

Abbreviations Used In This Manual

ACK	Acknowledgement (of frame)
ARCNET	Attached Resource Computer Network
CD	Compact Disk
DID	Destination Identifier
ERR	Error
FBE	Free Buffer Enquiry (for frame)
FIFO	First In First Out
ID	Identifier
ITT	Invitation To Transmit (frame)
LEN	Length of Packet
LP	Long Packet
NAK	Negative Acknowledgement (of frame)
PAC	Packet
PCI	Personal Computer Interface
RAM	Random Access Memory
SC	System Code
SID	Source Identifier
SP	Short Packet
USB	Universal Serial Bus

Hot-Keys Used by ARCNET Analyzer

Hot-Keys are *not* case-sensitive.

<u>Key</u>	<u>Description</u>
Ctrl—O	Load a Data File
Ctrl—S	Save to Log file
Alt—F	File menu
Alt—E	Edit menu (reserved for future use)
Alt—V	View menu
Alt—P	Option menu
Alt—H	Help menu

File Extensions Used by ARCNET Analyzer

<u>Extension</u>	<u>Type of File</u>
AAD	ARCNET Analyzer Data
CFG	ARCNET Analyzer Configuration
CSV	Comma Separated Variable
DLL	Dynamic Link Library
INF	Driver Setup Information
SYS	Driver

Data Rate Considerations

As shown below, at some data rates only certain transceivers are usable. Also, the Time Stamp interval and the duration of a RECON burst vary with the Data Rate.

Data Rate	Usable Transceivers	Time Stamp Interval	RECON Burst Duration
10 Mbps	COAX TP EIA-485 EIA-485X	2.5 μ s	0.689 ms
5 Mbps	COAX TP EIA-485 EIA-485X	5 μ s	1.377 ms
2.5 Mbps	COAX TP EIA-485 EIA-485X	10 μ s	2.754 ms
1.25 Mbps	EIA-485 EIA-485X	20 μ s	5.508 ms
625 kbps	EIA-485	40 μ s	11.016 ms
312.5 kbps	EIA-485	80 μ s	22.032 ms
156.25 kbps	EIA-485	160 μ s	44.064 ms

Using Multiple Instances of ARCNET Analyzer

Up to 5 USB Modules, each controlled by its own instance of **ARCNET Analyzer**, can capture data simultaneously from a single computer. In the Settings window, the **Device Number** specifies which USB Module will be controlled by the current instance of **ARCNET Analyzer**. This value refers to the unique USB Device Number assigned automatically by Windows when multiple USB devices are attached to the computer. If no number is chosen, a default of “0” causes one instance of **ARCNET Analyzer** to run.

Caution: Device Numbers *must differ*. If two instances have *matching* Device Numbers, the applications will freeze and power must be recycled to clear the condition.

Note: Only one *ana.cfg* configuration file may exist, regardless of the number of USB Modules may be in operation. That is, each instance of **ARCNET Analyzer** will launch with the same configuration settings retrieved from *ana.cfg*. Thus, for each instance of **ARCNET Analyzer** to have a unique configuration, it must be specified after startup.

Launching ARCNET Analyzer with the DOS Option

As with any program, **ARCNET Analyzer** can be opened from DOS. However, two optional DOS modes exist to provide continuous data capture and logging. Each mode is invoked when **ARCNET Analyzer** is opened with the command line:

analyzer x (where ‘x’ can be either ‘1’ or ‘2’)

When this DOS command is run, **ARCNET Analyzer** will launch and begin operating automatically using the configuration last stored in its *ana.cfg* file. The program will capture data continuously. Whenever the data buffer reaches capacity, its content will be saved—to the same folder from which **ARCNET Analyzer** is run—in a CSV file with a filename which is incremented using this format:

anaNN.csv

If the command is *analyzer 1*, *NN* is an incremental number in the range 1–100.

If the command is *analyzer 2*, *NN* an incremental number in the range 1–4294967296.

Caution: If **ARCNET Analyzer** is not stopped before saving file *anaMAXCOUNT.csv*, previously saved files will be overwritten. This is because after the highest numbered CSV is saved, the file counter resets to 1. At this point, the next file saved will be *ana1.csv* and each new file saved will overwrite an existing file of the same name.

Note: Before executing the DOS command, **ARCNET Analyzer** must have been run at least once in normal mode. This is needed to specify a configuration and cause the *ana.cfg* file to be created. If *ana.cfg* has not been created, this error will result: →

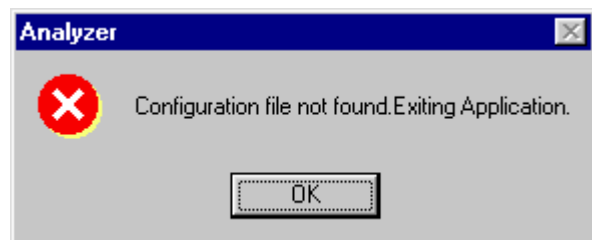

Error Messages

Error	Comment
254, 255 and 256 are data byte exception packets. Enter another packet length.	Packets of these lengths cannot be sent. They are called exception packets and must be padded with null data so that they can be sent as long packets.
Auto Restart and Manual Trigger cannot be used at the same time	Self-explanatory
Cannot Load USB Please check your power and cable and try again!	Self-explanatory
Cannot Write to 386 JTAG Port!	The JTAG Port has configuration issues needing attention.
Enter Destination ID between 0 and 255	A valid ARCNET destination node ID must be specified.
Enter Length between 1 and 507	A valid Packet Length must be specified.
Enter Source ID between 1 and 255	A valid ARCNET source node ID must be specified.
No Triggers are made. Insert Triggers	Data capture cannot proceed because no triggers have been defined although List Triggering mode has been checked.
No Triggers are Selected. Insert Triggers	The trigger specification of a retrieved file is improper for the current capture session.
Not Initialized	Data Rate, Port and Filter settings have not been downloaded to the USB Module.
Number of Triggers cannot exceed 16. Delete some triggers	Self-explanatory
Packet length error. The packet length for short packet varies from 1 to 253. Enter correct packet length	This error occurs when the entered packet length fails to conform to the ARCNET standard length for short packets.
Packet length error. The packet length for long packet varies from 257 to 508. Enter correct packet length	This error occurs when the entered packet length fails to conform to the ARCNET standard length for long packets.
PC to USB transfer failed	Check the USB cable connection. Recycling power and/or restarting ARCNET Analyzer may be needed.
Put the Offset Parameter	A Packet Data Value has been entered without a corresponding Offset.
Put the Value parameter for every input Offset	Each Packet Data Offset entry must have a valid Value entry.
Select Trigger Position	Self-explanatory
Settings Could not be Done	The retrieved file settings must be redefined.
USB to PC transfer failure	Check the USB cable connection. Recycling power and/or restarting ARCNET Analyzer may be needed.