

BASC22

22-point BACnet/IP Sedona Unitary Controller Series

BAScontrol22

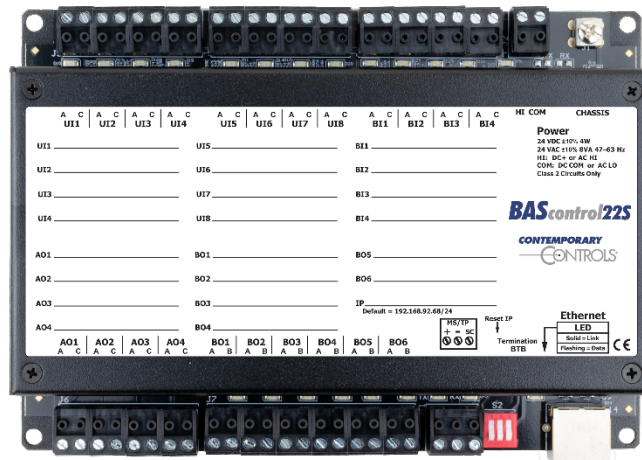

User Manual

UM-BASC22V4-AA0

Firmware Version 4.0.2

BASC-22DR

BASC-22SR

BASC-22WR

BASC-22WSR

CONTEMPORARY CONTROLS®

Trademarks

BASautomation, Contemporary Controls and CTRLink are registered trademarks of Contemporary Control Systems, Inc. BACnet is a registered trademark of the American Society of Heating, Refrigerating and Air-Conditioning Engineers, Inc. Other product names may be trademarks or registered trademarks of their respective companies.

Copyright

© Copyright 2023, by Contemporary Control Systems, Inc. All rights reserved. No part of this publication may be reproduced, transmitted, transcribed, stored in a retrieval system, or translated into any language or computer language, in any form or by any means, electronic, mechanical, magnetic, optical, chemical, manual, or otherwise, without the prior written permission of:

Contemporary Control Systems, Inc.	Tel:	+1-630-963-7070
	Fax:	+1-630-963-0109
	E-mail:	info@ccontrols.com
Contemporary Controls Ltd	Tel:	+44 (0)24 7641 3786
	Fax:	+44 (0)24 7641 3923
	E-mail:	ccl.info@ccontrols.com
Contemporary Controls (Suzhou) Co. Ltd	Tel:	+86 512 68095866
	Fax:	+86 512 68093760
	E-mail:	info@ccontrols.com.cn
Contemporary Controls GmbH	Tel:	+49 (0)341 520359 0
	Fax:	+49 (0)341 520359 16
	E-mail:	ccg.info@ccontrols.com

Disclaimer

Contemporary Control Systems, Inc. reserves the right to make changes in the specifications of the product described within this manual at any time without notice and without obligation of Contemporary Control Systems, Inc. to notify any person of such revision or change.

Contents

1	Introduction	4
1.1	Features and Benefits.....	5
1.2	Product Images and Main Features	6
2	Specifications.....	10
2.1	Power – Input Power	10
2.2	Universal Input (Channels UI1–UI8).....	10
2.3	Binary Inputs (Channels BI1–BI4).....	10
2.4	Analog Outputs (Channels AO1–AO4)	10
2.5	Relay Outputs (Channels BO1–BO6)	10
2.6	Data Link/Physical Layer Communication.....	11
2.7	Protocol Compliance	11
2.8	General Specifications	11
2.9	LED Indicators	12
2.10	Electromagnetic Compatibility.....	12
2.11	Field Connections.....	13
2.12	Power Connection.....	14
2.13	MS/TP Communications Port (22SR, 22WSR)	14
2.14	Wall Setter Port (22WS, 22WSR).....	14
2.15	Ordering Information.....	14
2.16	Dimensional Drawing	15
3	Installation	16
3.1	Power Supply	16
3.1.1	Power Supply Precautions.....	16
3.1.2	Limited Power Sources	16
3.1.3	Earth Connection	16
3.2	Cabling Considerations	17
4	Field Connections	18
4.1	Sample BASC22 Wiring Diagram	18
4.1.1	MS/TP Physical Layer Bias and Termination.....	20
4.2	Universal Inputs	20
4.2.1	Universal Input — Configured as Analog Input	20
4.2.2	Universal Input — Configured as a Binary Input.....	21

4.2.3	Universal Input — Configured as Temperature or Resistance Input	23
4.2.4	Universal Input — Configured as Pulse Input	24
4.3	Binary Inputs	25
4.4	Analog Outputs.....	26
4.5	Binary Outputs.....	27
4.6	LEDs	28
5	Configuration via a Web Browser.....	29
5.1	Ethernet Port.....	29
5.1.1	Auto-Negotiation.....	29
5.1.2	Auto-MDIX (Auto-Crossover).....	29
5.1.3	Reset Switch.....	29
5.1.4	Secure Login and Reset (Recovery Mode)	29
5.2	Web Server.....	30
5.2.1	Initial Access	30
5.3	BAScontrol22 Main Web Page	31
5.3.1	System Configuration.....	32
5.3.2	System Status	42
5.3.3	Set Time.....	43
5.3.4	Web Components (WC01–WC48).....	45
5.3.5	BACnet Utility	46
5.3.6	Restart Controller	47
5.3.7	Auto Refresh (On/Off).....	47
5.4	BAScontrol22 Main Web Page — Channel Configuration	47
5.4.1	Universal Input.....	49
5.4.2	Binary Inputs (Channels BI1–BI4)	53
5.4.3	Analog Outputs (Channels AO1–AO4).....	54
5.4.4	Binary Outputs (Channels BO1–BO6)	55
5.4.5	Virtual Points (Channels VT01–VT24)	56
6	Appendix.....	58
6.1	List of Installed Sedona Kits	58
6.2	Wall Setter Option	59
6.3	Protocol Implementation Conformance Statements (PICS)	61

1 Introduction

The BAScontrol22 Version 4.0 is a 22-point unitary controller series which supports BACnet/IP and Sedona over an Ethernet connection. There are four models in the 4.0 series. While all models support BACnet/IP over Ethernet, two models also have a MS/TP connection, and two models support a digital wall setter port for local setpoint control.

BASC-22DR	BAScontrol22 2-Ethernet
BASC-22SR	BAScontrol22 Ethernet MS/TP
BASC-22WR	BAScontrol22 2-Ethernet Wallset
BASC-22WSR	BAScontrol22 Ethernet MS/TP Wallset

All controller models comply with the B-ASC device profile with a convenient mix of 8 universal inputs, 4 binary inputs, 4 analog outputs and 6 relay outputs. Unique to the series are 48 web components which link Sedona wiresheet readable/writeable data to web pages, and 24 virtual points which link Sedona wiresheet readable/writeable data to a BACnet client. Each device is fully web page-configurable, and freely programmable using Sedona's drag-and-drop programming methodology of assembling components onto a wiresheet to create applications. Each unit can be programmed and archived using the BAScontrol Toolset. Rugged design, low profile, and wide temperature operation make the series suitable for indoor or outdoor use.

When discussing common specifications in the BAScontrol22 series, the product series reference BASC22 will be used. When discussing specifications unique to a product within the series, the actual model number will be used.

The BAScontrol22 series (BASC22) utilizes a powerful 32-bit ARM7 processor with 512 kB of flash memory, plus a 16 Mbit serial flash file system for storing configuration data and an application program. By operating at the BACnet/IP level, the BASC22 can share the same Ethernet network with supervisory controllers and operator workstations. The unit can be configured for a fixed IP address or can operate as a DHCP client receiving its IP address from a DHCP server. Time of Day is retained in a real-time clock (RTC) with a super-cap backup allowing for temporary data retention in the event of a power loss.

10/100 Mbps Ethernet ports support protocols such as BACnet/IP, Sedona Sox, HTTP, and FTP. Configuration of universal inputs and virtual points can be completed using web pages. Type II and Type III 10 k Ω thermistors curves as well as 20 k Ω and 100 k Ω curves are resident in the unit. The 100 k Ω follows the Tasseron (PSB) curve. Current inputs can be measured using external resistors. Contact closures require a voltage-free source. Binary inputs and outputs as well as analog outputs require no configuration. The unit is powered from a 24VAC/VDC source.

1.1 Features and Benefits

Versatile Control Device — field controller or remote Ethernet I/O

- BACnet/IP compliant client or server
- B-ASC device profile
- Configurable by the Sedona Application Editor (SAE) or a third-party Sedona tool
- Direct connection to an Ethernet network
- License-free Sedona function block programming
- Compliant with the BAScontrol Toolset
 - SAE
 - BASbackup Program Archive Utility
 - BASemulator

Flexible Input/Output — 22-points of I/O

- Eight configurable universal inputs: Thermistor, resistance, analog voltage, binary input, resistance, contact closure, pulse inputs (4 max)
- Four contact closure inputs
- Four analog voltage outputs
- Six relay outputs

Optional Features

- BACnet MS/TP client or server
- Proprietary wall setter input for the BASWS-M digital wall setter

1.2 Product Images and Main Features

Universal Inputs

Eight input points can be configured — all discoverable as BACnet objects.

- Analog inputs: 0–10 VDC, 12-bit resolution, 0–20 mA (with external resistor)
- Temperature inputs: Type II or Type III 10 kΩ thermistors; 20 kΩ thermistor, 100 kΩ thermistor
- Resistance inputs: 1 kΩ to 100 kΩ
- Contact closure, voltage-free
- Configure as binary inputs UI1-UI8
- Pulse input accumulators (UI1-UI4): accommodates active or passive sources (40 Hz max)

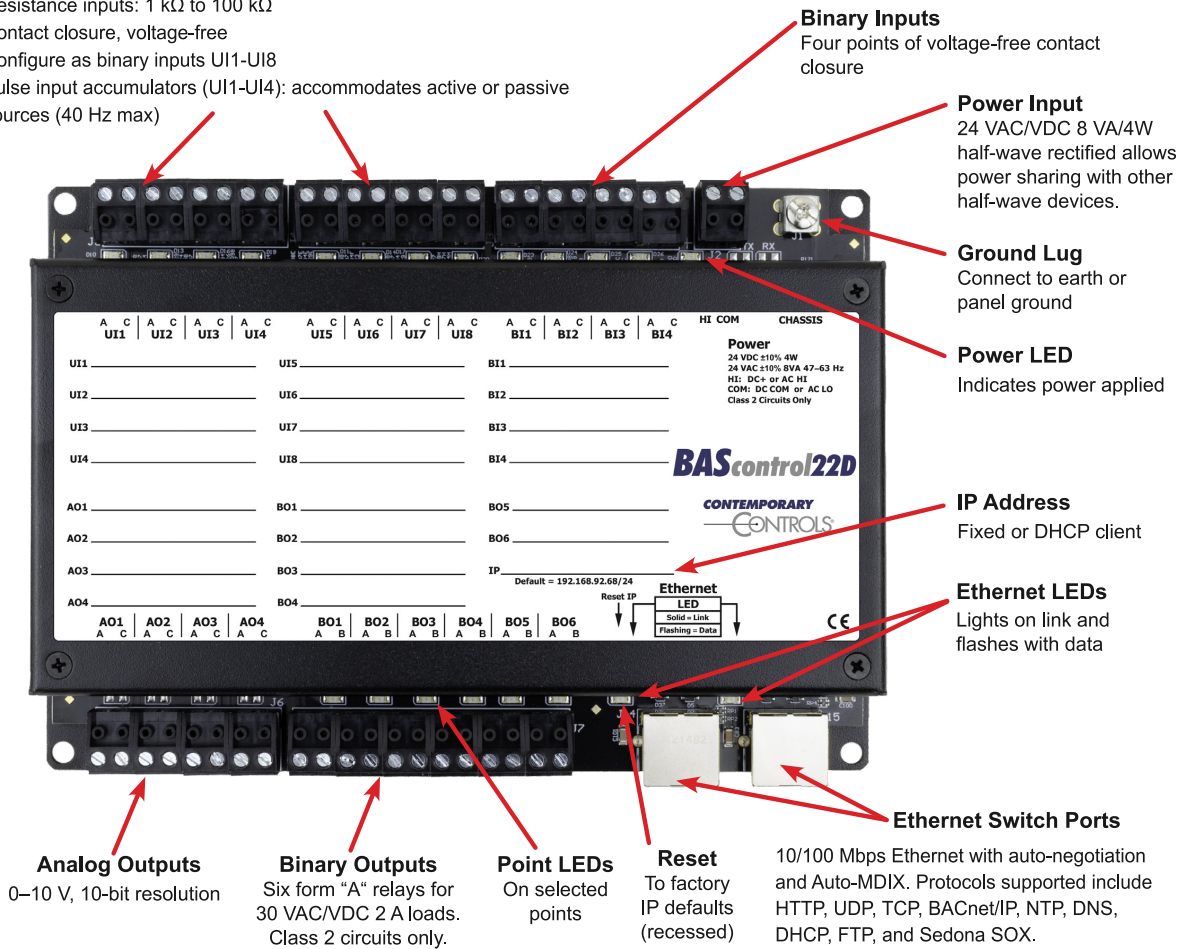

Figure 1a — BASC-22DR Main Features

Universal Inputs

Eight input points can be configured — all discoverable as BACnet objects.

- Analog inputs: 0–10 VDC, 12-bit resolution, 0–20 mA (with external resistor)
- Temperature inputs: Type II or Type III 10 kΩ thermistors; 20 kΩ thermistor, 100 kΩ thermistor
- Resistance inputs: 1 kΩ to 100 kΩ
- Contact closure, voltage-free
- Configure as binary inputs UI1-UI8
- Pulse input accumulators (UI1-UI4): accommodates active or passive sources (40 Hz max)

Binary Inputs

Four points of voltage-free contact closure

Power Input

24 VAC/VDC 8 VA/4W half-wave rectified allows power sharing with other half-wave devices.

Ground Lug

Connect to earth or panel ground

Power LED

Indicates power applied

IP Address

fixed or DHCP client

Ethernet LED

Lights on link and flashes with data

Ethernet Port

10/100 Mbps Ethernet with auto-negotiation and Auto-MDIX. Protocols supported include HTTP, UDP, TCP, BACnet/IP, NTP, DNS, DHCP, FTP, and Sedona SOX.

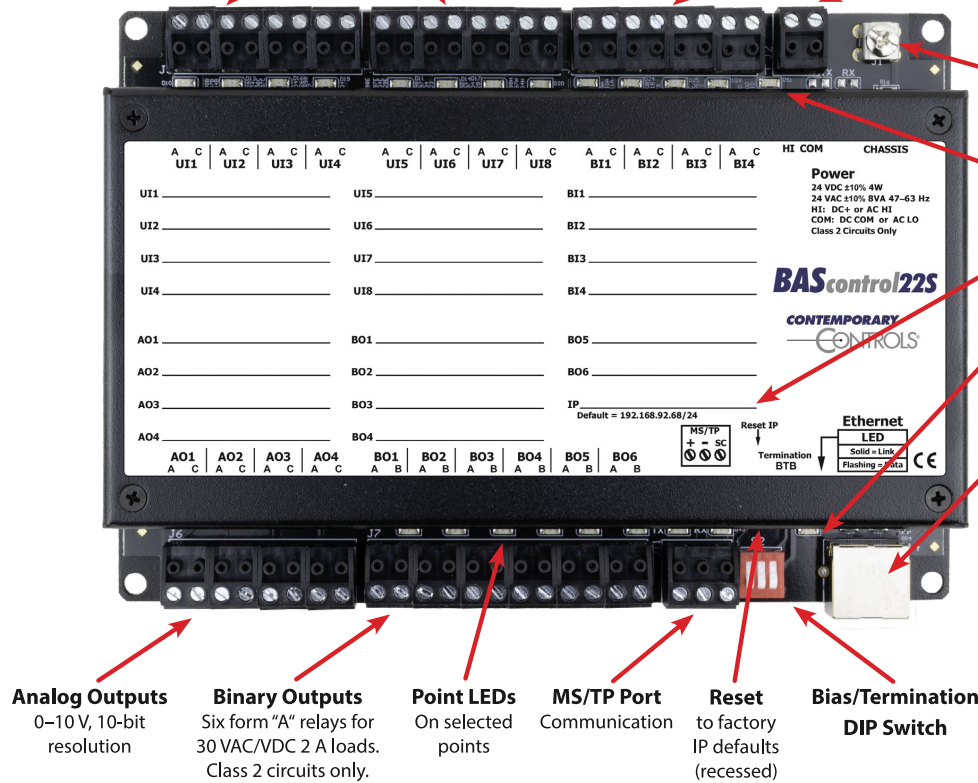

Analog Outputs

0–10 V, 10-bit resolution

Binary Outputs

Six form "A" relays for 30 VAC/VDC 2 A loads. Class 2 circuits only.

Point LEDs

On selected points

MS/TP Port

Communication

Reset

to factory IP defaults (recessed)

Bias/Termination DIP Switch

Figure 1b — BASC-22SR Main Features

Universal Inputs

Eight input points can be configured — all discoverable as BACnet objects

- Analog inputs: 0–10 VDC, 12-bit resolution, 0–20 mA (with external resistor)
- Temperature inputs: Type II or Type III 10 kΩ thermistors; 20 kΩ thermistor, 100 kΩ thermistor
- Resistance inputs: 1 kΩ to 100 kΩ
- Contact closure, voltage-free
- Configure as binary inputs UI1-UI8
- Pulse input accumulators (UI1-UI4): accommodates active or passive sources (40 Hz max)

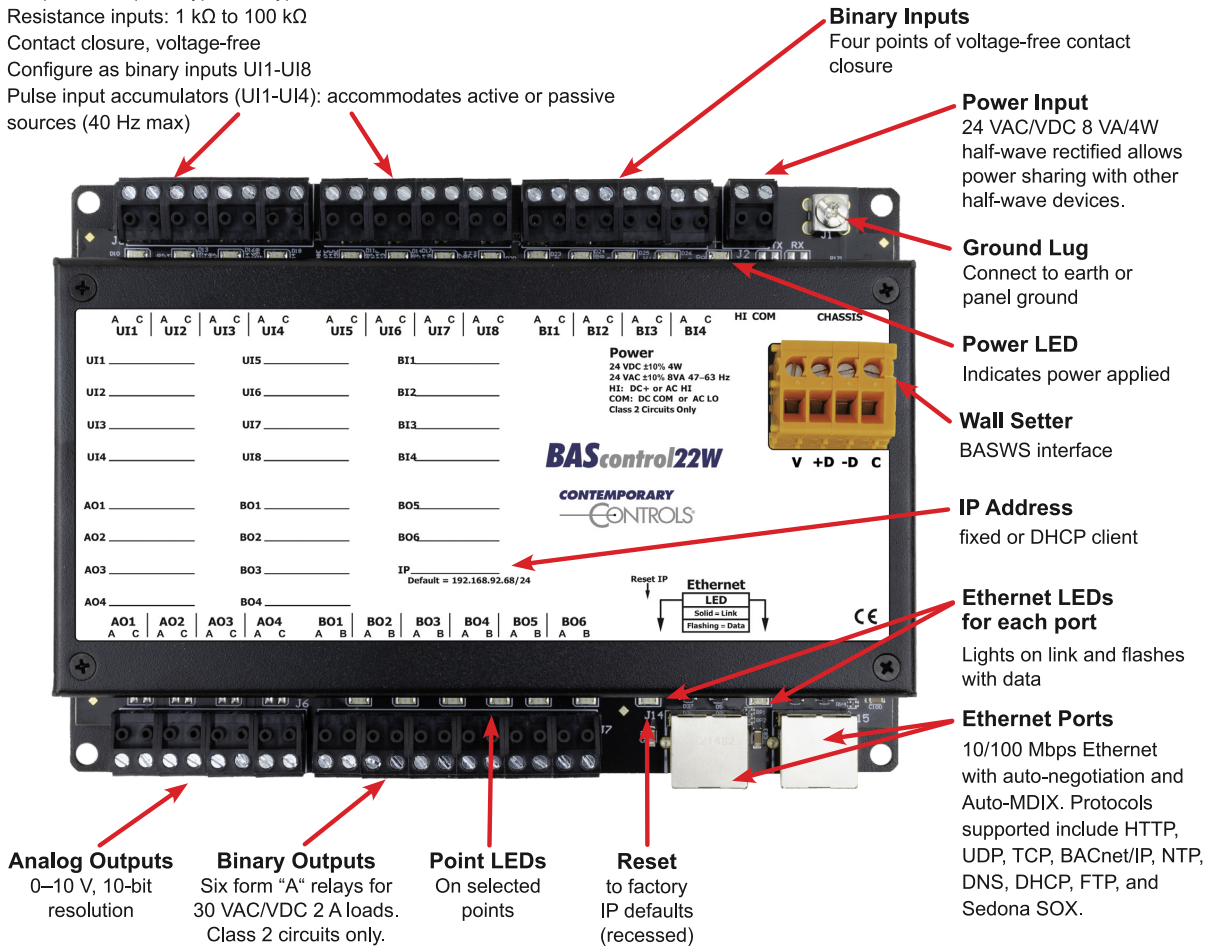

Figure 1c — BASC-22WR Main Features

Universal Inputs

Eight input points can be configured — all discoverable as BACnet objects.

- Analog inputs: 0–10 VDC, 12-bit resolution, 0–20 mA (with external resistor)
- Temperature inputs: Type II or Type III 10 kΩ thermistors; 20 kΩ thermistor, 100 kΩ thermistor
- Resistance inputs: 1 kΩ to 100 kΩ
- Contact closure, voltage-free
- Configure as binary inputs UI1-UI8
- Pulse input accumulators (UI1-UI4): accommodates active or passive sources (40 Hz max)

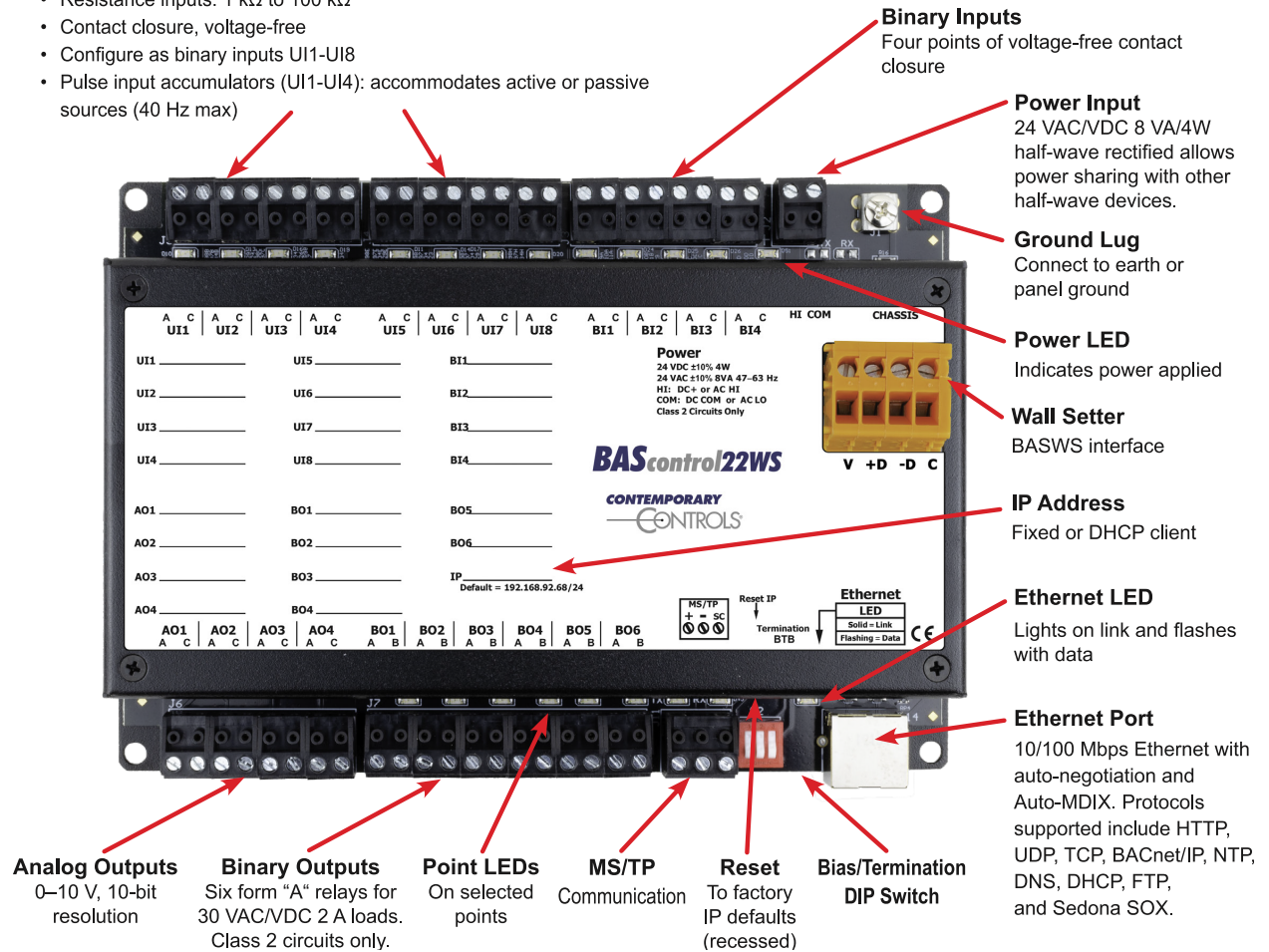

Figure 1d — BASC-22WSR Main Features

2 Specifications

2.1 Power – Input Power

Item	Limits
Input power	24 VAC/VDC \pm 10%, 47–63 Hz, 8 VA/4 W

2.2 Universal Input (Channels UI1–UI8)

Configured As	Limits
Analog Input	0–10 VDC or 0–20 mA (with external resistor). 12-bit resolution. Input impedance 1 M Ω on voltage. (NOTE: external resistors not provided)
Temperature Input	Type II 10 k Ω thermistor –10° to +190 °F (–23.3° to +87.8°C) Type III 10 k Ω thermistor –15° to +200 °F (–26.1° to +93.3°C) Type 20 k Ω thermistor 15° to 215° F (–9° to +101° C) Type 100 k Ω Tasseron (PSB) thermistor 68° to 338° F (20° to 170° C)
Contact Closure Input	Excitation current 0.5 mA. Open circuit voltage 12 VDC. Sensing threshold 3 VDC and below (logic TRUE) and 7 VDC and above (logic FALSE). Response time 20 ms.
Pulse Input (UI1–UI4)	1 M Ω input impedance for 0-10 VDC active output devices. Current sinking passive output devices will be pulled up internally to 12 VDC and must be capable of sinking 1.2 mA. 40 Hz maximum input frequency with 50% duty cycle. Adjustable high and low thresholds.
Resistance	1 k Ω -100 k Ω range

2.3 Binary Inputs (Channels BI1–BI4)

Configured As	Limits
Contact Closure	Excitation current 1.2 mA. Open circuit voltage 12 VDC. Sensing threshold 3 VDC and below (logic TRUE) and 7 VDC and above (logic FALSE). Response time 20 ms.

2.4 Analog Outputs (Channels AO1–AO4)

Configured As	Limits
Analog Output	0-10VDC. 10-bit resolution. 4 mA maximum.

2.5 Relay Outputs (Channels BO1–BO6)

Configured As	Limits
Binary Output	Form “A” relay (NO contact). 30 VAC/VDC 2 A. Class 2 circuits only. All contacts isolated from one another.

2.6 Data Link/Physical Layer Communication

Data Link	Compliance
Ethernet (1 or 2 ports)	IEEE 802.3 10/100 Mbps data rate 10BASE-T, 100BASE-TX physical layer 100 m (max) CAT5 cable length. Auto-negotiation of speed and duplex. Auto-MDIX.
MS/TP	BACnet Master-Slave/Token Passing. 9.6, 19.2, 38.4, 57.6, 76.8, 115.2 kbps data rate. EIA-485 physical layer: Represents one full load. Can support an additional 31 full-load devices (max); 1200 m (max) cable length (1000 m max for 115.2 kbps). DIP switch selectable bias and termination. (BASC-22SR and BASC-22WSR only).
Wall Setter	Proprietary protocol. 19.2 kbps data rate. EIA-485 physical layer: 100 ft. (max) with 24 VDC unfiltered 30 mA power for BASWS-M wall setter. (BASC-22WR and BASC-22WSR only).

2.7 Protocol Compliance

Protocol	Compliance
Internet	HTTP, FTP, UDP, TCP, NTP, DHCP. Default IP address is 192.168.92.68
BACnet	ANSI/ASHRAE 135 (ISO 16484-5) Release 15—a Data Communication Protocol for Building Automation and Control Networks. Application specific controller device profile B-ASC.
Sedona	SOX Sedona 1.2.28

2.8 General Specifications

Item	Description
Environmental	Operating temperature -40°C to +75°C. Storage temperature -40°C to +85°C. Relative humidity 10 to 95%, non-condensing.
Weight	0.8 lbs. (0.36 kg).
Regulatory	CE Mark; RoHS; UL 508, C22.2 #142-M1987 (Pending); UKCA

2.9 LED Indicators

LED Indicator	Indication
UI1–UI8 Configured as Analog Input	Green: > 1% of range, otherwise off
UI1–UI8 Configured as Temperature Input	Green: sensor detected
UI1–UI8 Configured as Contact Input	Green: contact closed, otherwise off
UI1–UI4 Configured as Pulse Input	Green: pulse sensed, otherwise off
UI1–UI8 Configured for Resistance	Green: resistance sensed
BI1–BI4 Contact Closure	Green: contact closed, otherwise off
BO1–BO6 Binary Output	Green: commanded output
Ethernet	Green: Link established; flashes with activity
MS/TP. TX (BASC-22SR, BASC-22WSR)	Green: flashes with transmit data
MS/TP. TX (BASC-22SR, BASC-22WSR)	Green: flashes with receive data
Wall Set. TX (BASC-22WR, BASC-22WSR)	Green: flashes with transmit data
Wall Set. RX (BASC-22WR, BASC-22WSR)	Green: flashes with receive data
Power	Green: Solid when power is applied

2.10 Electromagnetic Compatibility

Test Method	Description
EN 61000-4-2	Electromagnetic discharge immunity test
EN 61000-4-3	Radiated, radio frequency, electromagnetic field immunity test
EN 61000-4-4	Electrical fast transient/burst immunity test
EN 61000-4-5	Surge immunity test
EN 61000-4-6	Immunity to conducted disturbances, induced by radio-frequency fields
EN 61000-4-11	Voltage dips, short interruptions, and voltage variations immunity tests
CISPR 16	Conducted Emissions
CISPR 16	Radiated Emissions

2.11 Field Connections

Terminal	Universal Inputs 1–8	
UI1 A	Universal Input Point 1	High
UI1 C	Universal Input Point 1	Common
UI2 A	Universal Input Point 2	High
UI2 C	Universal Input Point 2	Common
UI3 A	Universal Input Point 3	High
UI3 C	Universal Input Point 3	Common
UI4 A	Universal Input Point 4	High
UI4 C	Universal Input Point 4	Common
UI5 A	Universal Input Point 5	High
UI5 C	Universal Input Point 5	Common
UI6 A	Universal Input Point 6	High
UI6 C	Universal Input Point 6	Common
UI7 A	Universal Input Point 7	High
UI7 C	Universal Input Point 7	Common
UI8 A	Universal Input Point 8	High
UI8 C	Universal Input Point 8	Common

Terminal	Analog Outputs 1–4	
AO1 A	Output Point 1	High
AO1 C	Output Point 1	Common
AO2 A	Output Point 2	High
AO2 C	Output Point 2	Common
AO3 A	Output Point 3	High
AO3 C	Output Point 3	Common
AO4 A	Output Point 4	High
AO4 C	Output Point 4	Common

Terminal	Binary Inputs 1–4	
BI1 A	Input Point 1	High
BI1 C	Input Point 1	Common
BI2 A	Input Point 2	High
BI2 C	Input Point 2	Common
BI3 A	Input Point 3	High
BI3 C	Input Point 3	Common
BI4 A	Input Point 4	High
BI4 C	Input Point 4	Common

Terminal	Relay Outputs
BO1 A	Output 1 Normally Open Contact
BO1 B	
BO2 A	Output 2 Normally Open Contact
BO2 B	
BO3 A	Output 3 Normally Open Contact
BO3 B	
BO4 A	Output 4 Normally Open Contact
BO4 B	
BO5 A	Output 5 Normally Open Contact
BO5 B	
BO6 A	Output 6 Normally Open Contact
BO6 B	

2.12 Power Connection

Terminal	Power
HI	High AC or DC +
COM	AC or DC common

2.13 MS/TP Communications Port (22SR, 22WSR)

Terminal	Signal
+	Positive Data
-	Negative Data
SC	Signal common (for 3-wire isolated MS/TP)

2.14 Wall Setter Port (22WS, 22WSR)

Terminal	Signal
V	Power Source
+D	Positive Data
-D	Negative Data
C	Power Common

2.15 Ordering Information

Model	Description
BASC-22DR	BAScontrol22 2-Ethernet
BASC-22SR	BAScontrol22 Ethernet MS/TP
BASC-22WR	BAScontrol22 2-Ethernet Wallset
BASC-22WSR	BAScontrol22 Ethernet MS/TP Wallset

2.16 Dimensional Drawing

The following dimensions apply to all models in the series. All units are in mm.

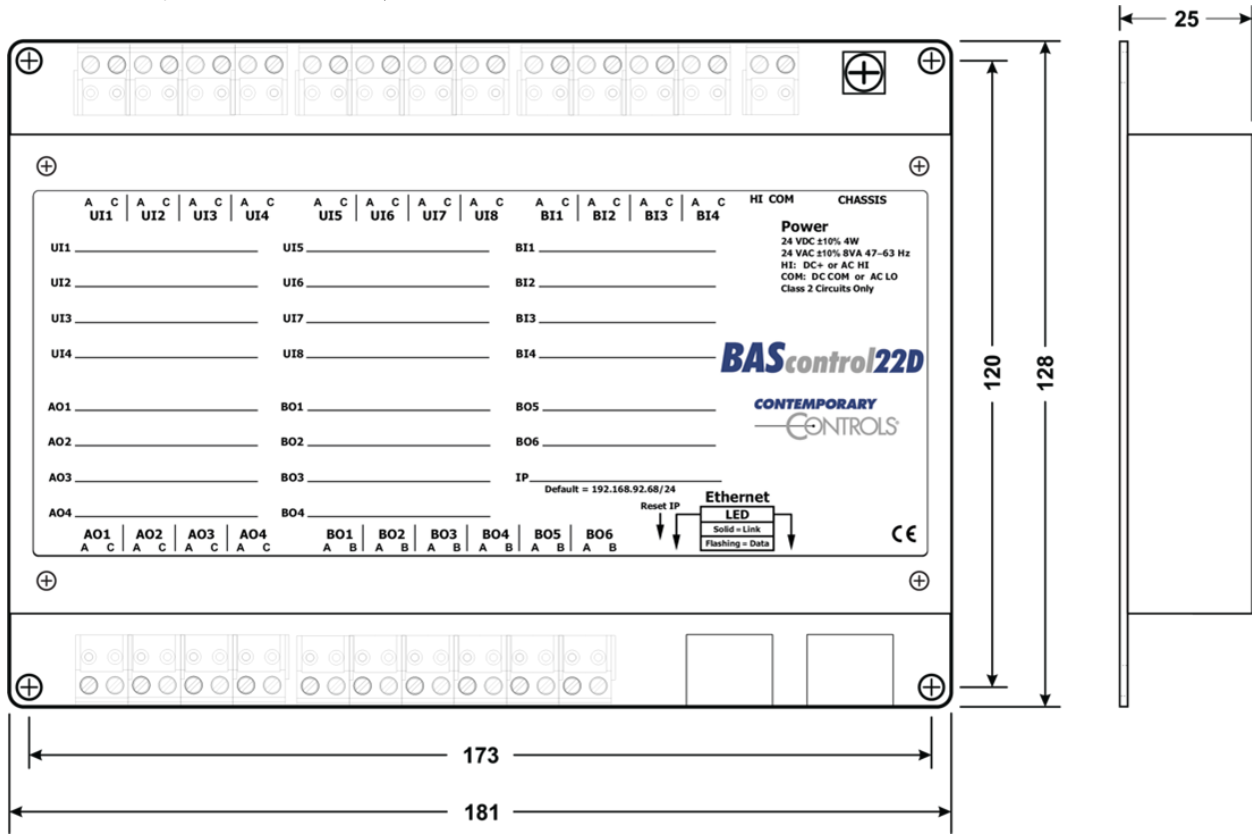

Figure 2 — BASC22 Series Dimensions

3 Installation

The BASC22 is intended to be panel-mounted with screws (not provided). The BAScontrol22 is outdoor temperature rated for a temperature range between -40°C and 75°C.

3.1 Power Supply

The power source for the internal supply is applied via the two terminals labelled HI and COM. COM is for the power source return and serves as the common ground connection. Primary 24 VAC/VDC ($\pm 10\%$) power is applied to HI and COM. HI connects to a diode and accomplishes half-wave rectified power—while providing reverse input voltage protection. The recommended power conductor size is 16–18 AWG (solid or stranded). Ground is directly connected to zero volts. Input connections are reverse polarity protected.

WARNING: Powering devices can present hazards. Read the next two sections carefully.

3.1.1 Power Supply Precautions

Internally, the BASC22 utilizes a half-wave rectifier and therefore can share the same AC power source with other half-wave rectified devices. Sharing a common DC power source is also possible. Sharing AC power with full wave rectified devices is NOT recommended. Full wave rectified devices usually require a dedicated AC power source that has a secondary elevated above ground. Both secondary connections are considered HOT. AC power sources that power several half-wave devices have a common secondary connection called COMMON, LO, or GROUND. This connection might be tied to earth. The other side of the secondary is considered the HOT or HI side of the connection. Connect the HOT side of the secondary to the HI input on the BASC22 and the LO side to COM on the BASC22. All other half-wave devices sharing the same AC power source need to follow the same convention. When using a DC power source, connect its positive terminal to the HI input on the BASC22 and the negative terminal to COM on the BASC22. Reversing polarity to the BASC22 will not damage the BASC22.

WARNING: Devices powered from a common AC source could be damaged if a mix of half-wave and full wave rectified devices exist. If you are not sure of the type of rectifier used by another device, do not share the AC source with it.

3.1.2 Limited Power Sources

The BASC22 should be powered by a limited power source complying with the requirements of the National Electric Code (NEC) article 725 or other international codes meeting the same intent of limiting the amount of power of the source. Under NEC article 725, a Class 2 circuit is that portion of the wiring system between the load side of a Class 2 power source and the connected equipment. For AC or DC voltages up to 30 volts, the power rating of a Class 2 power source is limited to 100 VA. The transformer or power supply complying with the Class 2 rating must carry a corresponding listing from a regulatory agency such as Underwriters Laboratories (UL).

3.1.3 Earth Connection

A ground lug has been provided on the BASC22 for connection to either earth or control panel ground. Use a green 16-18 AWG for connection.

3.2 Cabling Considerations

Function	Signaling and Data Rate	Minimum Required Cable	Maximum Segment Distance
Ethernet	10BASE-T 10 Mbps	Category 3 UTP	100 m (328 ft)
Ethernet	100BASE-TX 100 Mbps	Category 5 UTP	100 m (328 ft)
I/O	Unspecified	Solid: 16–22 AWG Stranded: 16–18 AWG	Unspecified
MS/TP	9.6-115.2 kbps	Stranded: one twisted pr. 24 AWG with foil shield* Connect Air W241P-2000F	1,200 m (4000 ft.) Except at 115.2 kbps, distance is 1000 m (3280 ft.)
Wall Setter	19.2 kbps fixed 8 data bits, even parity, one stop bit	Stranded: 22 AWG 4-conductor unshielded Connect Air W224C-2057RIB	30 m (100 ft.)

* If using shielded cable, connect to earth at only one point along the network.

NOTE: Wire size may be dictated by electrical codes for the area where the equipment is being installed. Consult local regulations.

Observe in the table that 10BASE-T segments can successfully use Categories 3, 4 or 5 cable—but 100BASE-TX segments must use Category 5 cable. Category 5e cable is highly recommended as the minimum for new installations.

The Ethernet port of the BASC22 employs Auto-MDIX technology so that either straight-through or crossover cables can be used to connect to the network.

4 Field Connections

4.1 Sample BASC22 Wiring Diagram

Powering and input/output wiring are the same on all models.

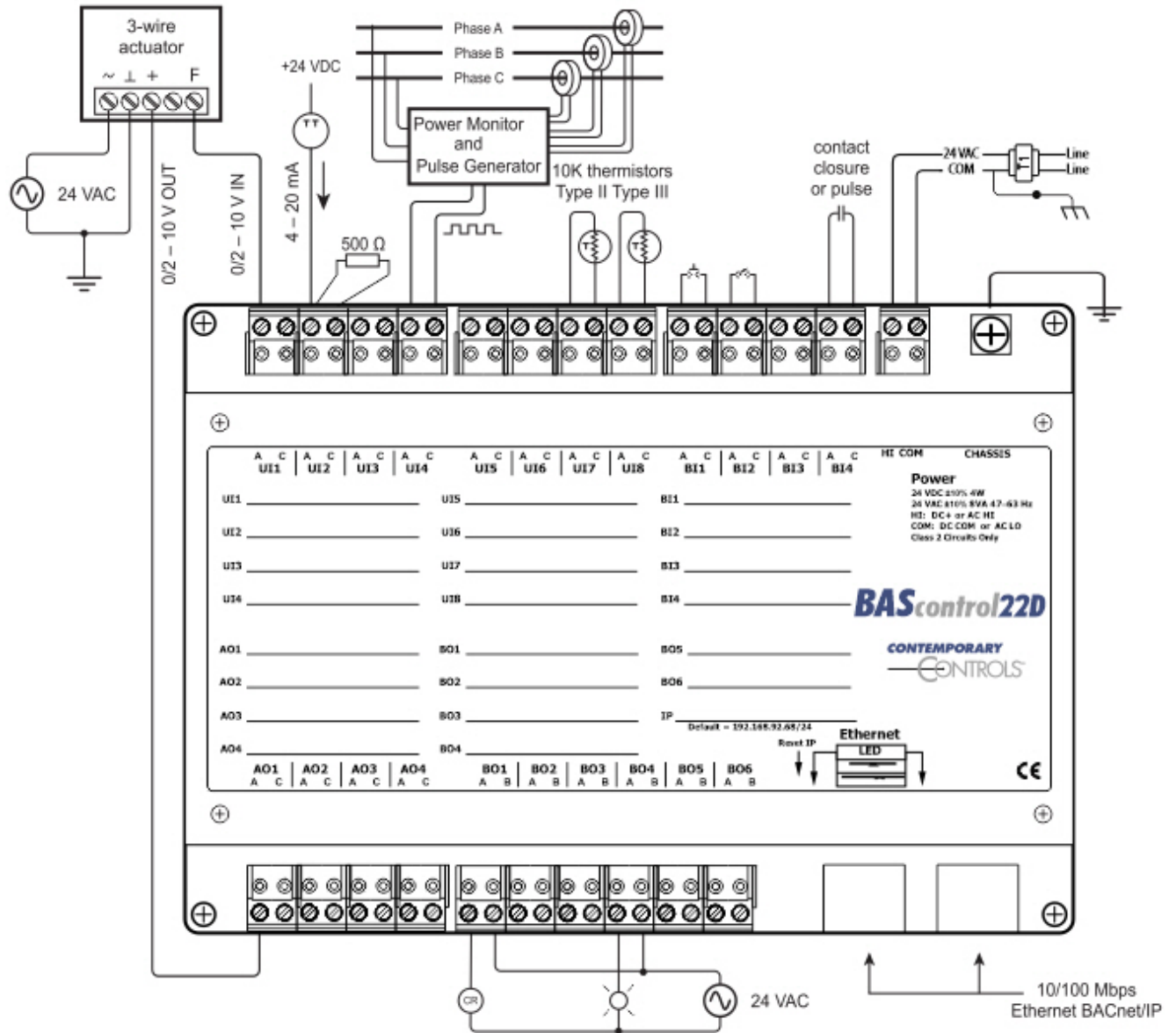

Figure 3a — Sample BASC-22DR Wiring Diagram

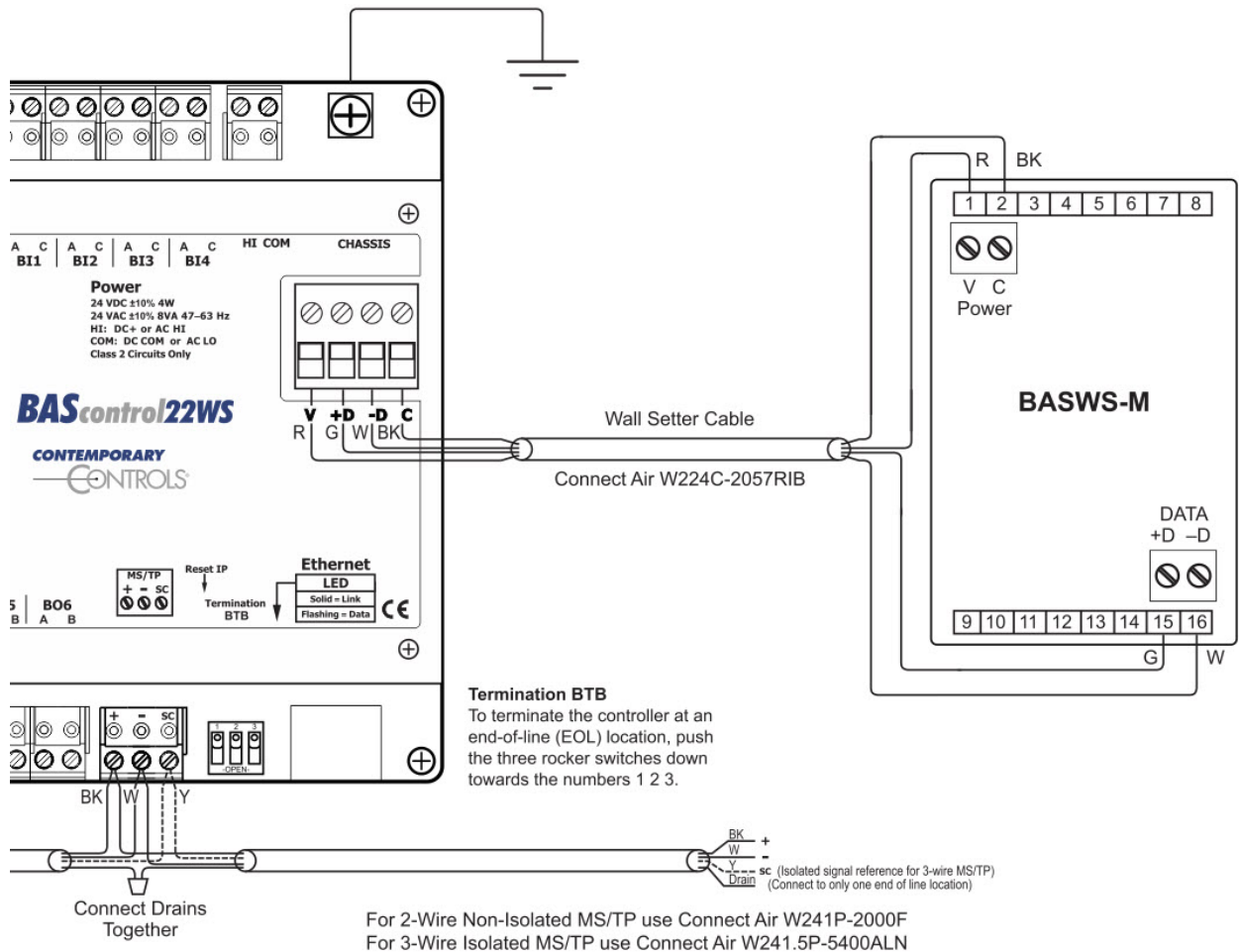

Figure 3b — Sample BASC-22WSR Wiring Diagram Showing the MS/TP and Wall Setter Wiring Option

4.1.1 MS/TP Physical Layer Bias and Termination

End-of-Line termination (120Ω) is normally applied at both ends of the MS/TP bus, especially when using long cable segments and faster data rates. Fail-safe voltage bias (200mV) ensures stable MS/TP operation. The BASrouter is shipped with fail-safe voltage bias and EOL termination applied.

Depending on the application, these can be changed by removing jumpers inside of the case.

End Device – In an application where the device is at the end of the MS/TP bus segment – both bias and EOL termination must be applied.

Middle Device – In an application where the device is anywhere between the end MS/TP devices (in the middle of the bus), termination jumper should be removed. Fail-safe voltage bias jumpers could be left in place depending on whether other devices on the MS/TP bus are providing additional bias or not.

Three configuration jumpers are located inside BASrouter's case near the MS/TP connector. Removing the BASrouter cover provides access to the 6-pin jumper block.

- 1 Install Jumper to apply pull-up bias
- 2 Install jumper to terminate bus
- 3 Install jumper to apply pull-down bias
(all jumpers are installed by default)

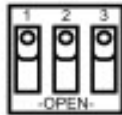

4.2 Universal Inputs

The BASC22 has eight universal inputs that can be configured to function as an analog input, a binary input, several versions of thermistor input, resistance input and a pulse input. With each configuration, BACnet settings can also be configured using a web browser.

4.2.1 Universal Input — Configured as Analog Input

An analog input can measure voltage in the range of 0–10 VDC or it can measure current in the range of 0–20 mA with a 500Ω external resistor. Transmitters that produce an elevated “zero” such as 2–10 VDC or 4–20 mA can be measured as well. Using the web page, configure the input for voltage. When set as a voltage input, the input impedance is $1\text{ M}\Omega$.

With voltage measurement, connect the more positive voltage to point A and the less positive to common C as shown in (Figure 4). On proportional damper actuators, the output signal is referenced to the damper's power supply common. That common must be at the same reference as the BASC22 common. Notice the connections in the diagram in the case of a separately powered actuator. In this situation it is necessary to attach the transmitter output to point A on the BASC22 input and a ground reference to C.

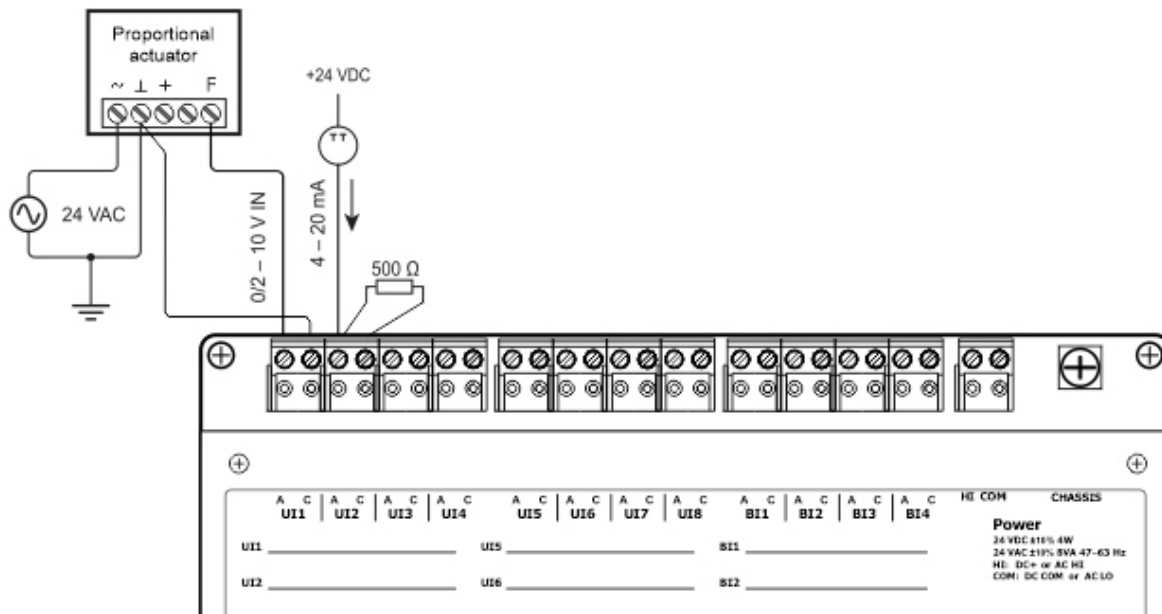

Figure 4 — Analog Input Connections

When measuring current from two-wire transmitters, remember the BASC22 sinks current to ground. A 500 Ω resistor is applied between points A and C on the input. To measure current, it must be driven into point A with respect to point C.

Care should be exercised when connecting to a three-wire current transmitter. These are usually non-isolated devices between the power source and signal output. The BASC22 will sink current from its input to ground so the transmitter must source current from a positive potential to ground. If the three-wire transmitter works in this manner, it can be accommodated.

Four-wire transmitters usually have isolation between power supply and signal output so their output stage can usually be treated as a two-wire transmitter.

4.2.2 Universal Input — Configured as a Binary Input

To sense the action of a push-button or relay, the contacts must have no externally applied energy, and be rated for low-voltage, low-current switching. The BASC22 provides the energy to be sensed. With a web browser, access the BAScontrol22 Main Page, click the title link of any Universal Inputs channel UI1–UI8. Set the Channel Type to Binary Input and the Units to NO_UNITS. As shown in the figure below, connect the contacts between points A and C. For common mechanical contacts, polarity is not an issue. The open-circuit voltage is 12 VDC and the short-circuit current is 0.5 mA.

For solid-state switch sensing, we recommend that an attached solid-state device have an opto-isolated open-collector NPN transistor output stage with a collector-emitter output voltage (V_{ce}) of at least 30 V. Output sinking current should be greater than 5 mA. The collector-emitter saturation voltage should be less than 0.2 V when sinking 2 mA. The emitter must be connected to point C and the collector to point A (the more positive point). The BASC22 sets the low-threshold to 3 V and the high-threshold to 7 V. When a contact is made or the solid-state switch is on (resulting in a saturated output), the voltage at point A is close to zero volts. The corresponding LED for that channel will be on. If the contact is opened or the solid-state switch is turned off, the voltage at point C quickly rises

towards 12 V. Once the voltage passes the 7 V high-threshold, the “off” state is sensed. To return to the “on” state, this voltage must fall below 3 V. The 4-volt difference is called hysteresis. There is no need to add an external pull-up resistor when using a contact closure input.

Contact closure inputs are sampled every 10 ms and for a change of state to be recognized, the input state must be stable for two consecutive samples.

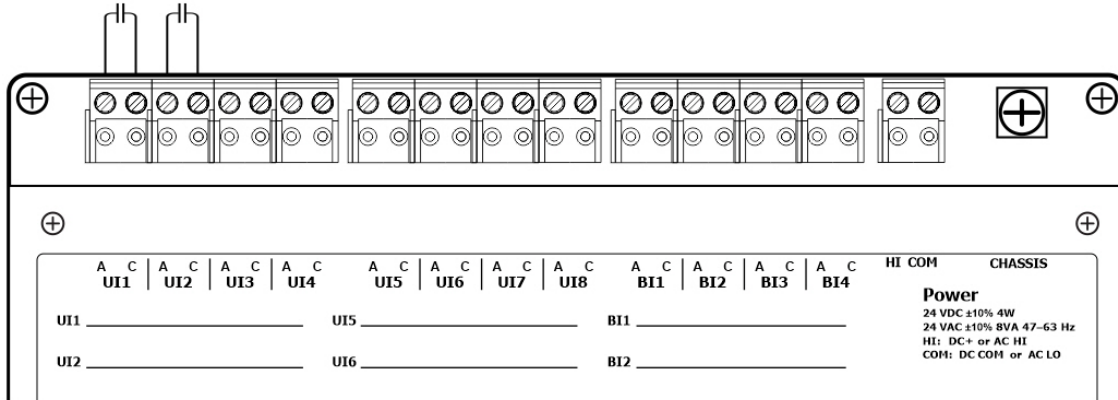

Figure 5 — Binary Input Connections

4.2.3 Universal Input — Configured as Temperature or Resistance Input

The BASC22 has built-in calibration curves for 10 kΩ Type II or Type III thermistors as well as 20 kΩ and 100kΩ thermistors. The 100 kΩ follows the Tasseron (PSB) curve. These devices have a non-linear negative coefficient of resistance to temperature and provide a nominal resistance of 10 kΩ or 20 kΩ at 25°C. With a web browser, configure an input Channel Type for either Type II or Type III thermistor or 20 kΩ. As shown in the figure below, connect the two-wire thermistor to points A and C. Polarity is not an issue. If averaging of temperature is desired, connect multiple thermistors in a series-parallel combination so that the nominal resistance remains at 10 kΩ or 20 kΩ as shown. Make sure that all devices are of the same type. The effective range of measurement varies by type:

- Type II 10 kΩ thermistor -10° to +190 °F (-23.3° to +87.8°C)
- Type III 10 kΩ thermistor -15° to +200 °F (-26.1° to +93.3°C)
- Type 20 kΩ thermistor 15° to 215° F (-9° to +101° C)
- Type 100 kΩ Tasseron (PSB) thermistor 68° to 338° F (20° to 170° C)

An open input results in a fault condition and no LED indication for that point.

Two-wire potentiometers used as setpoint stations can be read by the universal input by selecting resistance on the drop-down menu. The resistance range is from 1kΩ to 100kΩ. Connections are made just like thermistors, but linear curves are used during resistance measurement. If unique curve-fitting is required, this could be accomplished using the Linearize component in the Sedona component family.

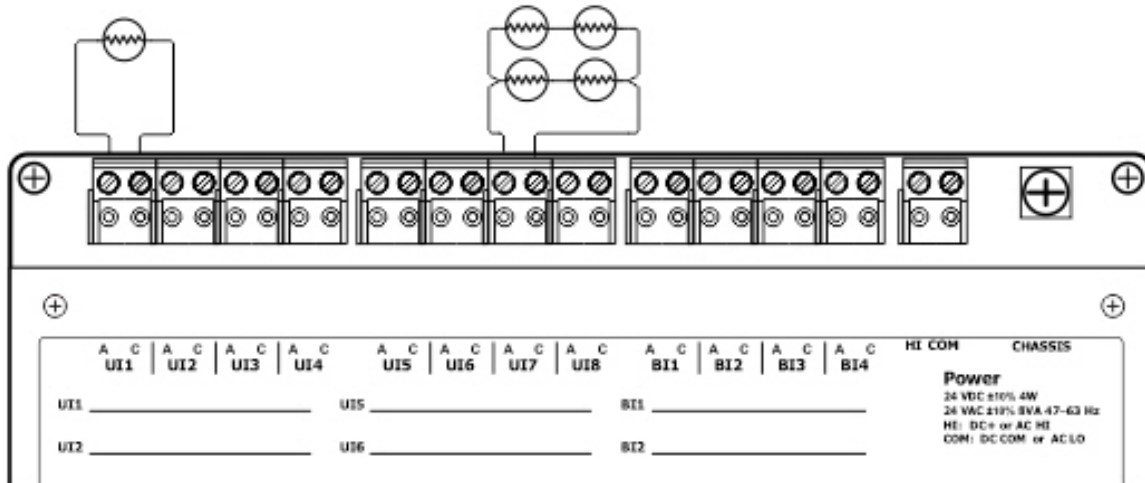

Figure 6 — Thermistor and Resistor Connections

4.2.4 Universal Input — Configured as Pulse Input

When an input (UI1 – UI4) is configured for Pulse Input, a pulse rate up to 40 Hz can be measured, assuming a 50% duty cycle. The pulse device could have an active output or a passive output requiring a pull-up resistor. Both situations can be accommodated.

The input voltage range is 0–10 VDC and the installer can set both the low-threshold and high-threshold on the Pulse Input web page. The difference in the two thresholds is the hysteresis. You can detect a sinusoidal input by setting the high threshold below the positive peak and the low threshold above the negative peak. Setting both thresholds well away from the sinusoidal waveform peaks offers some noise immunity. It is not necessary for the input to swing from zero to 10 V. Any substantial swing within this range can be detected. The input impedance using Pulse Input is 100 k Ω when using active sensors. Connect the output of the pulse device to point A and the common to point C, as shown in the figure below.

If the pulse device has a passive output requiring a pull-up resistor, the BASC22 can provide a 10 k Ω resistor to +12 VDC by checking a box on the configuration page. The two threshold values can still be set as needed.

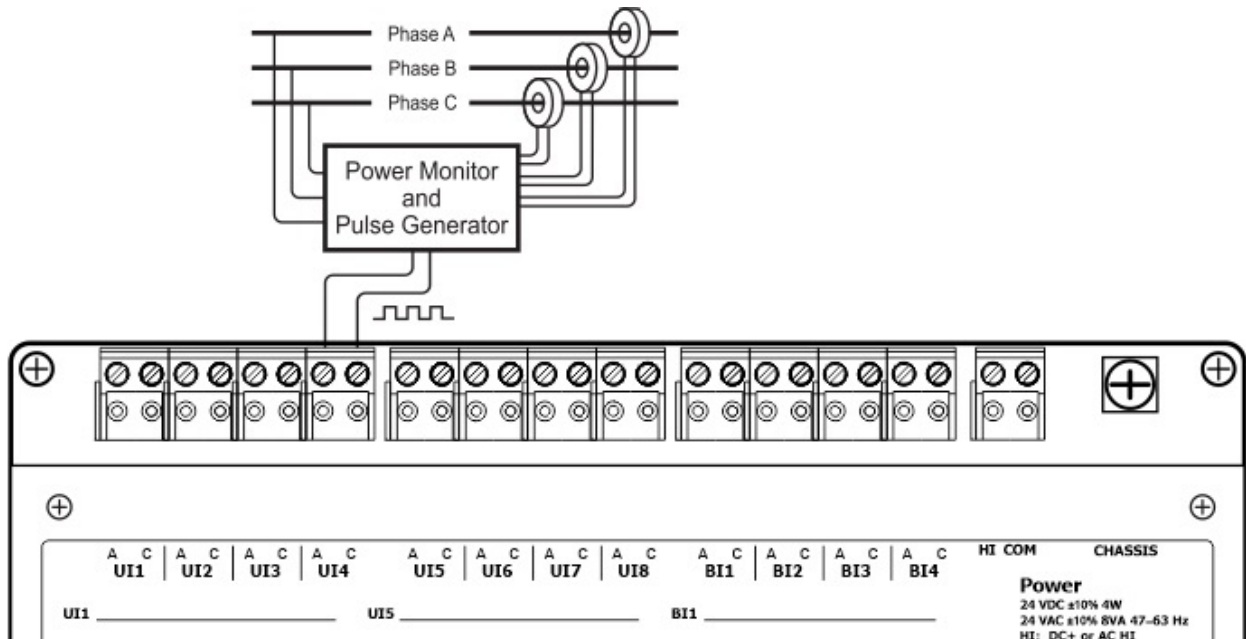

Figure 7 — Pulse Input Connections

Data Retention

Time of Day is retained in an RTC with a super-cap backup allowing for temporary data retention in the event of a power loss. In addition, the data for pulse input accumulators in UI1–UI4 is also retained. The super-cap is derated as temperature increases. At the highest temperature rating of the BAScontrol22, retention is typically two days. At room temperature, retention could be at least seven days.

4.4 Analog Outputs

Voltage in the range of 0–10 VDC can be outputted by assigning analog outputs (AO1–AO4). For analog output DC voltage, the output voltage is applied to point A with respect to C (common). There is no configuration necessary for analog outputs.

The figure below illustrates connections to a proportional damper actuator but with a separate power supply. The damper requires a 0–10 V command signal which can easily be accomplished by the BASC22. If position feedback is to be measured, connect the actuator output signal to UI1 and configure the universal input for analog input.

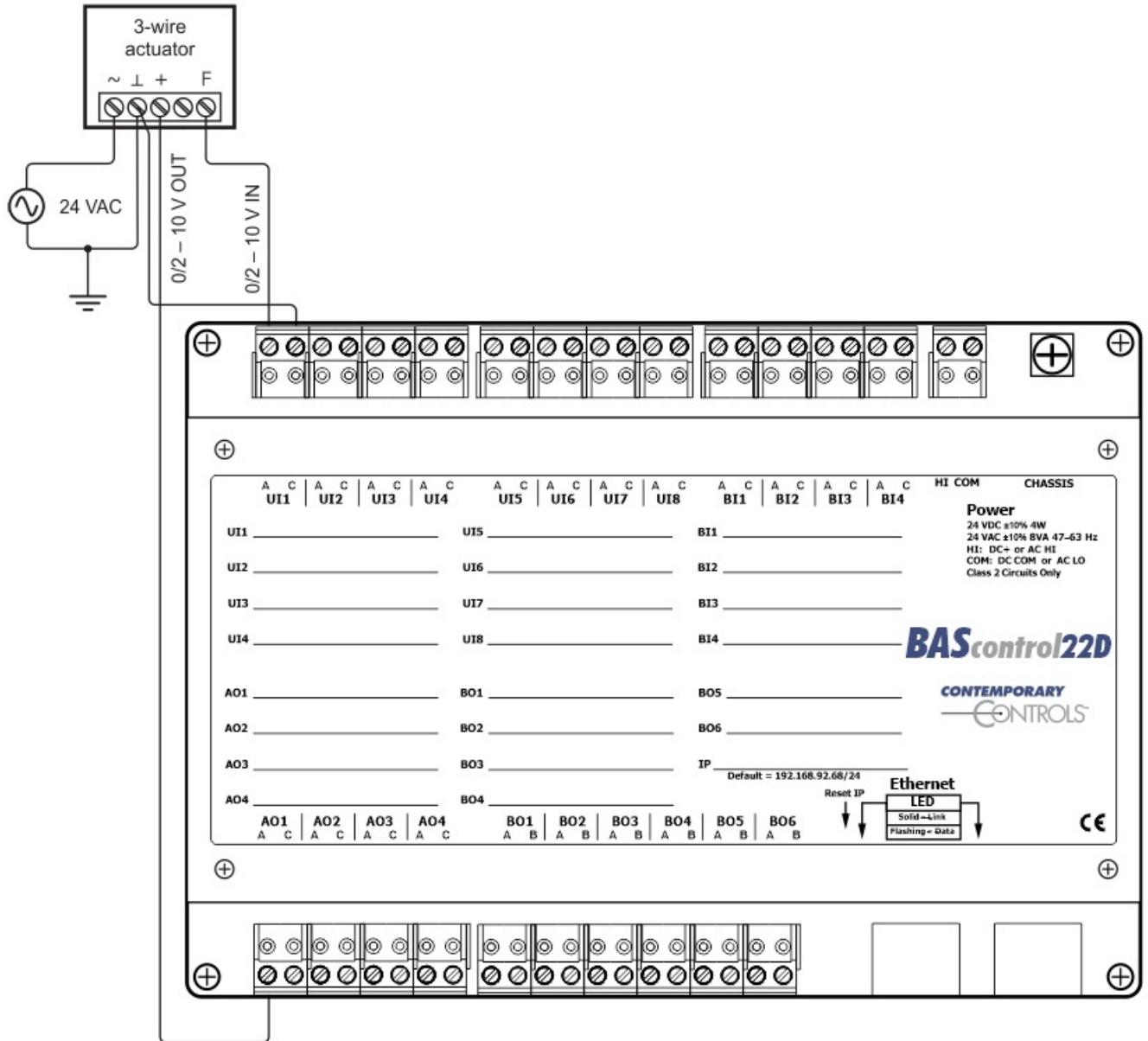

Figure 9 — Analog Output Connections

4.5 Binary Outputs

As shown in the figure below, six binary outputs (BO1 - BO6) are available. The BASC-22 provides six normally open form "A" relay contacts that are rated at 30 VAC/VDC and 2 A. Each contact pair is isolated from the other relays and labelled A and B to assist in documenting wiring. These contacts are intended for switching Class 2 wiring circuits only.

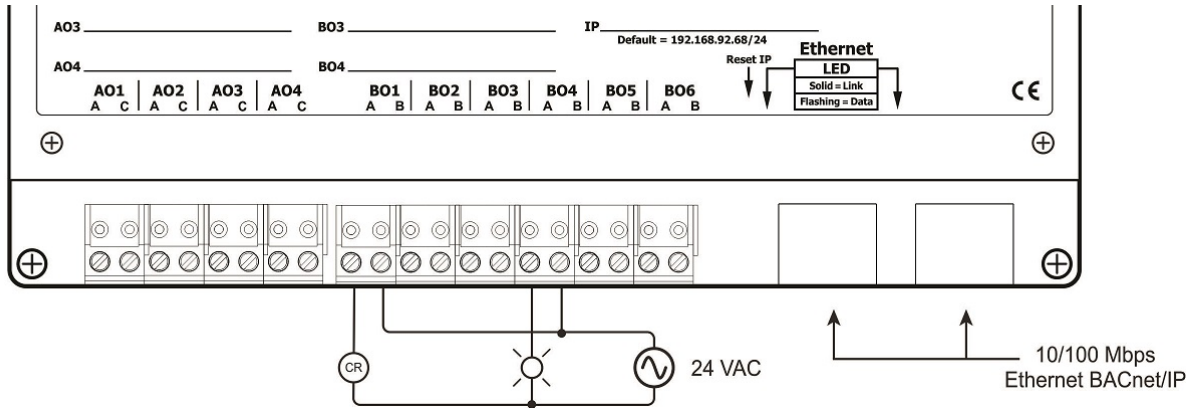

Figure 10 — Binary Output Connections

4.6 LEDs

To aid in troubleshooting, several LEDs have been provided.

The BASC22 has an Ethernet LED that glows green when properly linked to equipment operating at 10/100 Mbps and indicates activity by flashing. For the BASC-22WSR with MS/TP and Wall Setter, the TX LED flashes while transmitting data, and the RX LED flashes with receiving data.

LEDs to indicate I/O status follow the behavior described in the table below:

If the I/O channel is ...	Green indicates ...
a Relay output	the coil is energized.
a Contact input	the contact is made.
a Pulse input	the input state changed.
a Thermistor	thermistor is connected.
a Resistor	resistor is connected.
an Analog input	the signal is greater than 1% of span.

5 Configuration via a Web Browser

Some configurations of the BASC22 are required. This is accomplished while the unit is connected to a computer running a web browser (JavaScript-enabled) that accesses the unit's built-in web server. No other tools are required.

5.1 Ethernet Port

Depending on the model, one or two 10/100 Mbps Ethernet ports are available for configuration. Either one will do.

5.1.1 Auto-Negotiation

The Ethernet ports on the BASC22 offer full auto-negotiation. A single cable links two Ethernet devices. When these devices auto-negotiate, the data rate will be 100 Mbps only if both are capable of that speed. Likewise, full duplex will only be selected if both can support it. If only one device supports auto-negotiation, then it will default to half-duplex mode and match the data rate of the non-auto-negotiating device.

5.1.2 Auto-MDIX (Auto-Crossover)

When interconnecting two Ethernet devices, a straight-through cable or crossover cable can be used—but if one device uses Auto-MDIX, the cable wiring does not matter; Auto-MDIX adjusts for either type.

5.1.3 Reset Switch

To reset the BASC22 to its default values of the IP address (192.168.92.68) and netmask (/24 or 255.255.255.0), press the reset switch (see Figure 1) while the unit is powered. Follow the instructions under the section 5.1.4.

5.1.4 Secure Login and Reset (Recovery Mode)

To reset the unit to its default IP values and login credentials, press the reset switch (recess located) for more than 10 seconds while the unit is powered. (See Figure 1 for the switch location.) This forces the **recovery mode** — confirmed by a quickly flashing Status LED. This action restores the default settings for the user ID (admin), password (admin), IP address (192.168.92.68) and subnet mask (255.255.255.0). Access the BAScontrol22 Main Page and make changes to the IP configuration and login credentials (see section 5.3.1.3, IP and DNS Configurations for more details). Then click **Restart Controller** to exit recovery mode.

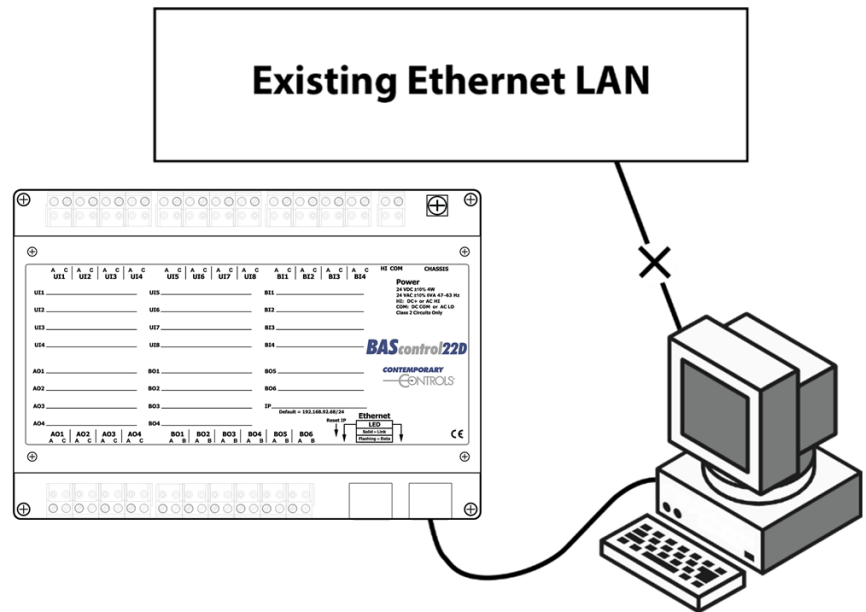

Figure 11 — Setup for Initial IP Address Configuration by Web Browser

5.2 Web Server

The BASC22 contains an interactive web server, accessible from any Internet-compatible PC on the local network. It is compatible with all recent browsers. It is factory programmed with a default IP address of 192.168.92.68 and a Class C subnet mask of 255.255.255.0. Once configured, changing its IP address is strongly encouraged to avoid any station conflicts.

5.2.1 Initial Access

The hardware arrangement for initially setting the BASC22 IP address appears in Figure 11. The PC should be temporarily disconnected from the Ethernet LAN in case the BASC22's default address matches that of a device on the existing LAN. The procedure for altering the IP address creates a temporary LAN composed of nothing but the BASC22, the PC used to configure it and a CAT5 cable connecting the two. Since the BASC22 supports Auto-MDIX, either straight-through or crossover cable can be used.

For initial configuration, the PC chosen for the procedure should temporarily have its IP address modified which employs a Windows® example.

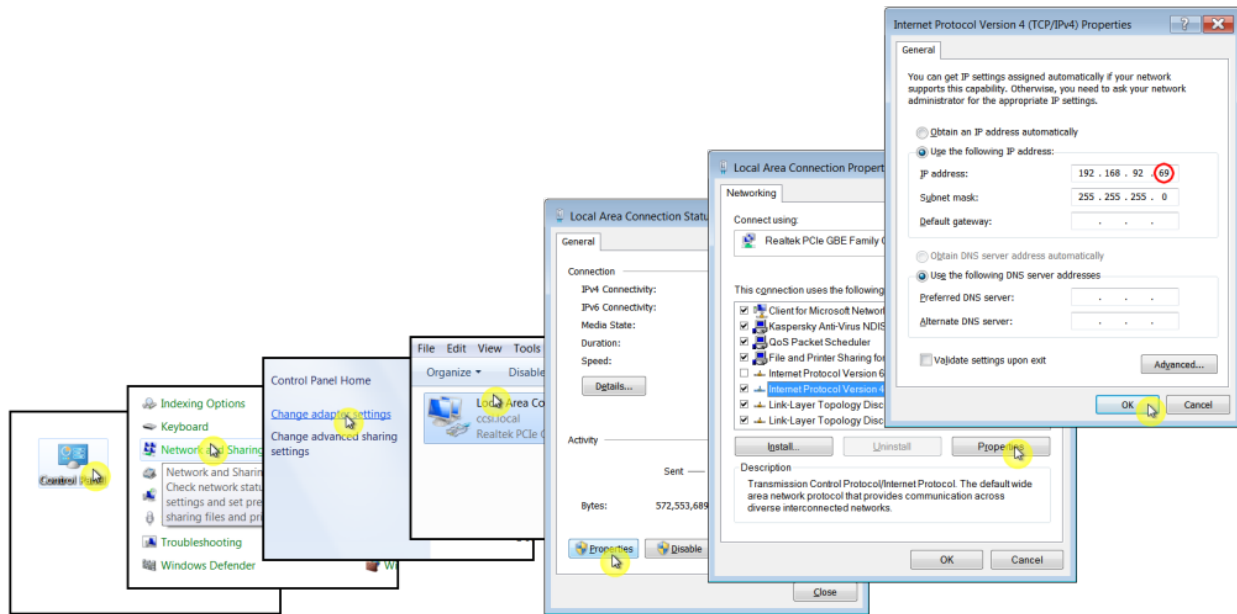

Figure 12 — Steps for Changing the IP Address of the PC Used for Setup

The figure above uses an IP address for the PC of 192.168.92.69, but the final quad of the address could be any value 1–254 except for 68 which is used by the BASC22. After setting the IP address of the PC to the same LAN as the BASC22, a browser can access the BASC22 default IP address.

When first accessing the BASC22, you must provide the default login credentials. We strongly advise you to change these values.

5.3 BAScontrol22 Main Web Page

Once you successfully login to the controller the main page appears. The top of the page displays channel data for the 22 BACnet hardware input/output points:

- Universal Inputs (Channels UI1–UI8)
- Binary Inputs (Channels BI1–BI4)
- Analog Outputs (Channels AO1–AO4)
- Binary Outputs (Channels BO1–BO6)

Eight buttons occupy the bottom of the main page. One button provides access to the 24 BACnet soft input/output points, called virtual points, while another button provides access to the 48 web components. The button functions are as follows:

- System Configuration
- System Status
- Set Time
- Virtual Points (Channels VT01-VT24)
- Web Components (Channels WC01-WC48)
- BACnet Utility
- Restart Controller
- Auto Refresh (On/Off)

Each of the channel types have three features:

- Title link — If clicked, it displays a configuration screen.
- Data field* — You can read a value or enter one if forced.
- Checkbox* — If checked, you can force the channel value.

***Checkboxes Enable Forcing**

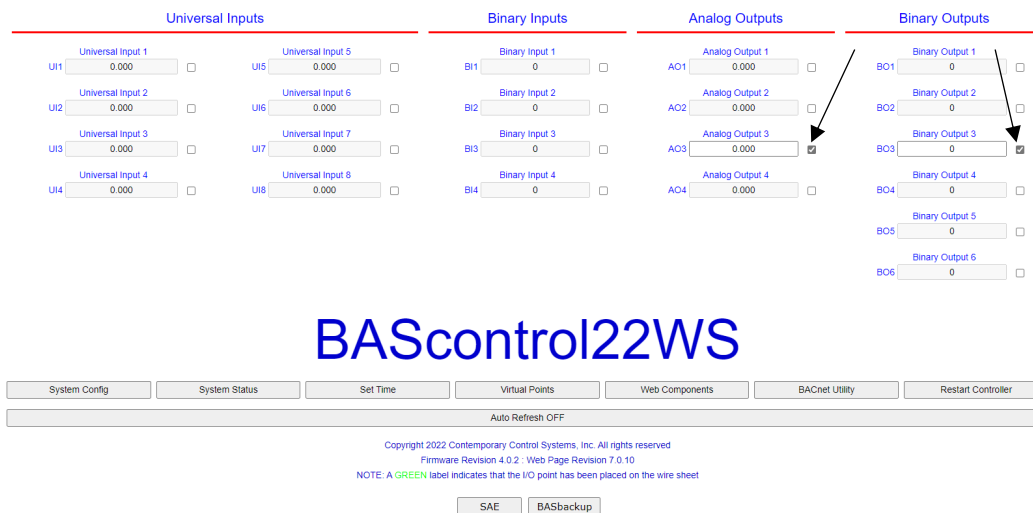

Figure 13— BAScontrol22WSR Main Page

5.3.1 System Configuration

From the BAScontrol22 Main Page, click the **System Config** button to open the System Configuration window. The page opens under the **Admin** tab where you can enable various protocols and change your authorization credentials.

The screenshot shows the 'System Configuration' window for the BASC-22WSR. At the top, there is a navigation bar with tabs for 'Admin', 'Wired/IP', 'BACnet', and 'MSTP'. The 'Admin' tab is active. To the right of the tabs are 'Close' and 'Submit' buttons. Below the navigation bar is a section titled 'Enable Protocol' with a red underline. This section contains five checkboxes: 'BACnet/IP' (checked), 'BACnet MS/TP' (unchecked), 'Sedona' (checked), 'Wall Setter' (checked), and 'FTP' (unchecked). Below the 'Enable Protocol' section is another section titled 'Authentication' with a red underline. This section contains two input fields: 'User Name' with the value 'admin' and 'Password' with a masked value '.....'.

Figure 14 — System Configuration Window for the BASC-22WSR

The System Configuration web pages differ slightly depending upon model. Only the 22WSR model displays the five checkboxes (as shown in the figure above), with File Transfer Protocol (FTP) disabled by default.

5.3.1.1 Enable Protocol/ Authentication

Enable Protocol

A maximum of five checkboxes will appear in the Enable Protocol screen. BACnet MS/TP will only appear on the 22SR and 22WSR models, while Wall Setter will only appear on the 22WR and 22WSR models.

- **BACnet/IP** Disabling (on by default) will free more memory for Sedona.
- **BACnet MS/TP** Disabling frees up CPU time polling for unused MS/TP port.
- **Sedona** Disabling Sedona (on by default) will free more memory for BACnet.
- **Wall setter** Disabling will free up CPU time polling for uninstalled wall setter.
- **FTP** If needed, enable FTP (which is disabled by default since it is only used a service function). If you select FTP, all other buttons are automatically de-selected.

Disabling unused protocols offers potential savings in CPU usage or memory space. However, it is not necessary to disable them. If any protocol is changed, you must click **Submit**.

Authentication

As previously mentioned, we strongly advise you to change the default **Username** and **Password** (*admin/admin*).

- You can use up to 32 characters to specify your **Username** and **Password**.
- Alphanumeric and the following characters are acceptable:
~!@#\$%^&*()_+-|}{`[]\';,./?*><
- Do not use emojis, UTF-8 hex pre translation values [0x], and non-U.S. characters.

5.3.1.2 IP and DNS Configurations

Click the **Wired/IP** tab to access the IP and DNS Configuration window. The following parameters can be adjusted, then click **Submit**:

- **IP Mode** Choose either **Static IP** (the default) or **DHCP**.
- **Address** Changing the default value of 192.168.92.68 is recommended.
- **Netmask** The default value of 255.255.255.0 is adequate for most users.
- **Gateway** If your Ethernet LAN has a gateway (router) enter its IP address here.
- **Primary DNS1** Enter your primary domain name service address.
- **Secondary DNS2** Enter your secondary domain name service address.

After the BASC22 has been given its initial configuration, it will be ready for use in the full original Ethernet network. The temporary network constructed in Figure 11 should be dismantled and the PC re-configured to restore its original IP address.

The screenshot shows a configuration window with a blue header bar containing tabs: Admin, **Wired/IP**, BACnet, and MSTP. On the right side of the header are buttons for Close and Submit. Below the header, the title "IP Configuration" is centered. The configuration fields are as follows:

IP Mode	STATIC
Address	192.168.92.200
Netmask	255.255.250.0
Gateway	192.168.92.1

Below the IP configuration, the title "DNS Configuration" is centered. The DNS fields are:

DNS1	8.8.8.8
DNS2	8.8.4.4

Figure 15 — IP and DNS Configuration Window for the BASC-22WSR

5.3.1.3 BACnet Configuration

Click the **BACnet** tab to access the BACnet and BACnet Client Configuration window. The following parameters can be adjusted, then click **Submit**:

- **Device Name** You must change the default object name (BAScontrol System) to be **unique** throughout the **entire BACnet internetwork**.
- **Device Instance** This 22-bit value (0–4,194,303) **must be unique** throughout the **entire BACnet internetwork**. It defaults to **2749**.
- **UDP Port** The default of 47808 should usually not be changed.
- **BBMD IP Address** Enter the address of the BBMD with which the BASC22 will perform Foreign Device Registration (FDR) — if the BBMD is not in the same subnet as the BASC22. If not communicating with a BBMD, leave at 0.0.0.0.
- **BBMD Reg Time** Specify the seconds between successive FDR registrations. Default is 100.
- **Time Sync (mins.)** Set the interval in minutes at which the time sync message will be sent. Check box options for BIP and MS/TP (BASC-22SR and BASC-22WSR models only) appear when a non-zero value is entered. A zero (default) that the message will not be sent.

Admin	Wired/IP	BACnet	MSTP	Close	Submit
-------	----------	---------------	------	-------	--------

BACnet Configuration

Device Name	<input type="text" value="BAScontrol22WS"/>
Device Instance	<input type="text" value="383"/>
UDP Port	<input type="text" value="47808"/>
BBMD IP Address	<input type="text" value="0.0.0.0"/>
BBMD Reg Time	<input type="text" value="100"/>
Time Sync (min.)	<input type="text" value="5"/>
	BIP <input type="checkbox"/> MS/TP <input type="checkbox"/>

BACnet Client

Poll Delay (ms)	<input type="text" value="1000"/>
Retry Delay (ms)	<input type="text" value="10"/>
<input type="button" value="Configure BACnet Servers"/>	

Figure 16 — BACnet and BACnet Client Configuration Window for the BASC-22WSR

Note: After checking the submit button after any change you must restart the controller from the main web page.

Configure BACnet Clients

One feature of the BAScontrol 4.0 upgrade is that each model in the series can function as both a BACnet server and BACnet client. By default, each BAScontroller is a BACnet server meaning that it does not initiate requests to other devices other than an initial “I-Am” request when first joining the network. However, any BACnet client on the BACnet internetwork can request data from a BAScontroller and receive a response. This activity requires no configuration of the BAScontroller because this server action is native to the BAScontroller. However, with some configuration, the BAScontroller can also become a BACnet client and request data or command data from other BACnet servers attached to the BACnet internetwork. This capability requires some configuration, and the use of custom Sedona components found in the CControls_BASCC_NETV kit resident in all BAScontrol 4.0 controllers. For more information, refer to **Configure BACnet Server Points** below.

Each BAScontrol 4.0 controller has one BACnet/IP port, and some models (BASC-22SR and BASC-22WSR) have a BACnet MS/TP port. Both the BACnet/IP and BACnet MS/TP ports can become client ports, provided the MS/TP port is enabled. A BACnet/IP client can request data from any BACnet/IP server on the same BACnet network, while a BACnet MS/TP client can request data from any BACnet MS/TP server on the same BACnet MS/TP network. If the BAScontroller is a BASC-22SR or BASC-22WSR, both client ports can be used simultaneously. If the BAScontroller is a BASC-22DR or BASC-22WR with one BACnet/IP port, the controller can request data from a BACnet server on the same BACnet network in addition to a BACnet MS/TP controller on a BACnet MS/TP network accessible through a BACnet router, such as the BASrouter.

To configure the BAScontroller as a BACnet client, simply confirm the following settings:

- **Poll Delay (ms)** To avoid generating excessive network traffic, set the polling interval to a reasonable rate such as 1,000 ms.
- **Retry Delay (ms)** Set the retry delay if a response is not received.

When using the BACnet client feature, it is necessary to identify the location of the BACnet servers that are to be accessed. This is performed by clicking **Configure BACnet Servers**. The resulting windows and selections vary depending upon the type of BACnet client and BACnet server being selected.

Important: Before you **Configure BACnet Servers**, if you are configuring a model with a BACnet MS/TP port (BASC-22SR or BASC-22WSR) and you intend to use the MS/TP port, you must first configure the MS/TP port on the controller as described in the next section **5.3.1.4 MS/TP Configuraton**. Then you can proceed with configuring a BACnet server.

Configure a BACnet/IP Client to BACnet/IP Server Via Direct Connection

Click **Configure BACnet Servers**, then from the pop-up window, click **Add Server**. This is the most straight-forward selection.

- Do not check **Routed** or **MS/TP** check boxes.
- Enter a unique **Server Name**. It does not need to be the actual BACnet device name.
- Enter the **Device Instance**. It is not necessary to enter the true Device Instance. This number should be unique from all other entered Device Instances and used in the NetV to reference the configured device.
- Enter the **Local IP Address**.
- Click **Submit**.

The screenshot shows the 'BACnet Servers' configuration window. The 'Servers' tab is active. The 'Server' dropdown is set to 'GT 382'. The 'Routed' and 'MS/TP' checkboxes are both unchecked. The 'Server Name' field contains 'GT 382', the 'Device Instance' field contains '382', and the 'Local IP' field contains '10.0.3.82'. At the bottom, there are buttons for 'Revert', 'Submit', 'Delete Server', and 'Add Server'. A 'Close' button is located below the main form area.

Figure 17 — Configure BACnet Server

Configure a BACnet MS/TP Client to BACnet MS/TP Server Via Direct Connection

This scenario is only a slight variation of the above configuration applicable to the BASC-22SR and BASC-22WSR with a resident MS/TP port located on the same BACnet network as the target MS/TP server.

- Check the **MS/TP** check box, do not select **Routed**. This changes the selection slightly—instead of requesting a local IP address, you are prompted for the local MAC address.
- Enter a unique **Server Name**. It does not need to be the actual BACnet device name.
- Enter the **Device Instance**. It is not necessary to enter the true Device Instance. This number should be unique from all other entered Device Instances and used in the NetV to reference the configured device.
- Enter the **MAC Address**.
- Click **Submit**.

The screenshot shows the 'BACnet Servers' configuration window. The 'Servers' tab is active. The 'Server' dropdown is set to 'GT 383'. The 'Routed' checkbox is unchecked and the 'MS/TP' checkbox is checked. The 'Server Name' field contains 'GT 383', the 'Device Instance' field contains '383', and the 'MAC Address' field contains '125'. At the bottom, there are buttons for 'Revert', 'Submit', 'Delete Server', and 'Add Server'. A 'Close' button is located below the main form area.

Figure 18 — Configure BACnet MS/TP Client to BACnet MS/TP Server

Configure a BACnet/IP Client to BACnet MS/TP Server Via BACnet Router

In this scenario we are reaching out to an MS/TP device not attached to our local MS/TP (assuming we have one) but to a BACnet MS/TP network reachable from the IP side of a BACnet/IP router connected to a MS/TP network.

- Check **Routed** and **MS/TP** since the target address is a MS/TP MAC address behind a BACnet/IP to MS/TP router. When checking both **Routed** and **MS/TP**, you are also required to enter the BACnet **Router Address**, BACnet **Network** Address, and **Remote Address** (MAC Address) of the target server.

Refer to **Finding Devices with Contemporary Controls' BACnet Discovery Tool (BDT)** below to learn how use the BDT to discover this information.

- Enter a unique **Server Name**. It does not need to be the actual BACnet device name.
- Enter the **Device Instance**. It is not necessary to enter the true Device Instance. This number should be unique from all other entered Device Instances and used in the NetV to reference the configured device.
- Enter the **Router Address**—the IP address of the BACnet router.
- Enter the **Network**—the BACnet MS/TP network number on the BACnet router
- Enter the **Remote Address**—MAC address of the target server
- Click **Submit**. Repeat the process for adding more server devices.

Once you have submitted all your server selections, you will need to click **Restart Controller** on the Main Web Page. If you happened to have SAE open on the controller to be reset, make sure to save your application program because you will need to login again to the controller after the restart and you do not want to lose any unsaved work.

BACnet Servers

Servers Wire Sheet Components

Server: GT 4141004

Routed MS/TP

Server Name: GT 4141004

Device Instance: 4141004

Router Address: 10.0.0.218

Network: 218

Remote Address: 5

Revert Submit

Delete Server Add Server

Close

Figure 19 — Configuring a BACnet/IP Client to BACnet MS/TP Server

Find Devices with Contemporary Controls' BACnet Discovery Tool (BDT)

The configuration is a bit more complex, but it can be easily located using Contemporary Controls' BACnet Discovery Tool (BDT). BDT can be downloaded for free from the company's website and is a handy tool for searching BACnet devices.

First, with the BDT application running on your computer, search for devices on the BACnet network. This will provide the IP address of the BACnet router (along with the BACnet UDP port); the BACnet network number on the other side of the BACnet router; and the MAC address of the target server.

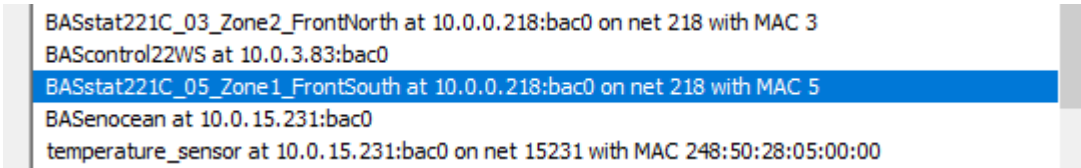

Figure 20 — Using the BDT to Discover Router Address, Network, and Remote Address

Next, double-click the selected device to obtain the object list. In this example, the Device Object is at the top of list and shows a **Device Instance** of 4141004.

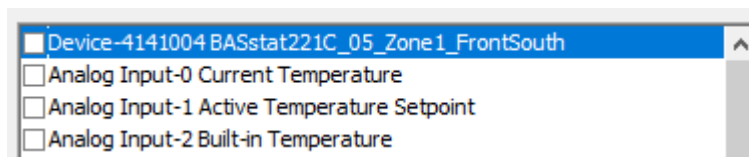

Figure 21 — Using the BDT to the Get Object List

Configure BACnet Server Points

Once the BACnet servers are identified, you can bring in BACnet server points onto the client BAScontroller's wiresheet. Network Variable (NetV) Sedona components provide the method for reading BACnet objects from remote BACnet server devices onto the client controller's wiresheet, or for writing to BACnet objects on the remote BACnet server from the client controller's wiresheet.

NetV components are available in the CControls_BASCC_NETV kit pre-installed on the BAScontrol 4.0 controllers. Using a Sedona tool, drag the desired NetV components from the NetV kit onto the wiresheet.

If you expand the kit, you will find the following components:

- > CControls_BASC22S_IO
- > CControls_BASC22S_Platform
- > CControls_BASC22S_Web
- ▼ CControls_BASCC_NETV
 - NETVAI4 [252B]
 - NETVAO4 [272B]
 - NETVAV4 [272B]
 - NETVBI4 [240B]
 - NETVBO4 [260B]
 - NETVBV4 [260B]
 - NetV [116B]
- > CControls_Function
- > CControls_Function2
- > CControls_HVAC
- > CControls_Math
- > CControls_Math2
- > CControls_P_HVAC2

Figure 22 — CControls_BASCC_NETV kit Components

Besides the single-point NetV component, there are quad-point components for inputting analog inputs (AI), analog outputs (AO), binary inputs (BI), binary outputs (BO), analog values (AV), and binary values (BV). The single-point NetV is the most comprehensive component in the group because it can be configured for either an input or an output. Knowing how to configure this component will ease the understanding of the quad components that are either fixed input or fixed output components.

This NetV example corresponds with the routed MS/TP example previously mentioned. Again, BDT is a handy tool for determining not only the device instance but all the object instances on each server. Notice the BDT DevInstance in this example is 4141004.

In the first slot, the **Device Instance** must be entered followed by the **Object Instance** of the point to be either read or written. From the **Obj Type** dropdown in SAE, match the object type with what BDT discovered. In this example, it is an *Analog Input*.

The **Priority** slot is for outputs with the BACnet range of 1 through 16, with 1 having the highest priority. The default value is 10. **DefOutF**, **DefOutB**, and **DefOutI** are slots used for setting a safe default value for float, binary, and integer variables if communication is lost (goes offline).

ValF, **ValB**, and **ValI** represent the float, binary, and integer present value of the data sent by the server point. This occurs when **Enable** is false, meaning server data is directed to the client's wiresheet (read mode). If **Enable** is true, then data flows from the client's wiresheet to the server point (write mode).

The **Relinquish** slot is also used with outputs. If **Relinquish** is true, the BAScontrol will send a writeProperty command with a value of "null" that relinquishes a previous write at the NetV's set priority. It will not send the value in the ValF, ValB, or ValI slots.

Status shows the communications status. It could be Online or Offline.

Detailed information on how to use NetV components to read/write binary and analog inputs, values, and outputs can be found in the "[Sedona Open Control Reference Manual](#)" on the company's web site.

Clicking on the **Wiresheet Components** tab brings up more configuration settings. Using the **Component** drop down, you can select each NetV component on the wiresheet. You need to set the device instance of the server and the object instance of the point being accessed.

NetV3	
CControls_BASCC_NETV::NetV	
DevInstance	4141004
ObjInstance	2
ObjType	AnalogInput
Priority	10
DefOutF	0.0
DefOutB	false
DefOutI	0
ValF	80.5
ValB	true
ValI	80
Relinquish	false
Enabled	false
Status	Online

Figure 23 — CControls_BASCC_NETV kit Components

BACnet Servers

Servers
Wire Sheet Components

Component NetV

Device Instance 383

Object Instance 1

Object Type Analog Input

Action Wire Sheet <- Server Object

Status Offline

Value 0.000

Refresh Component
Reload Components

Close

Figure 24 — Wiresheet Components Window

5.3.1.4 MS/TP Configuration (BASC-22SR, BASC-22WSR)

This section applies for models that support MS/TP.

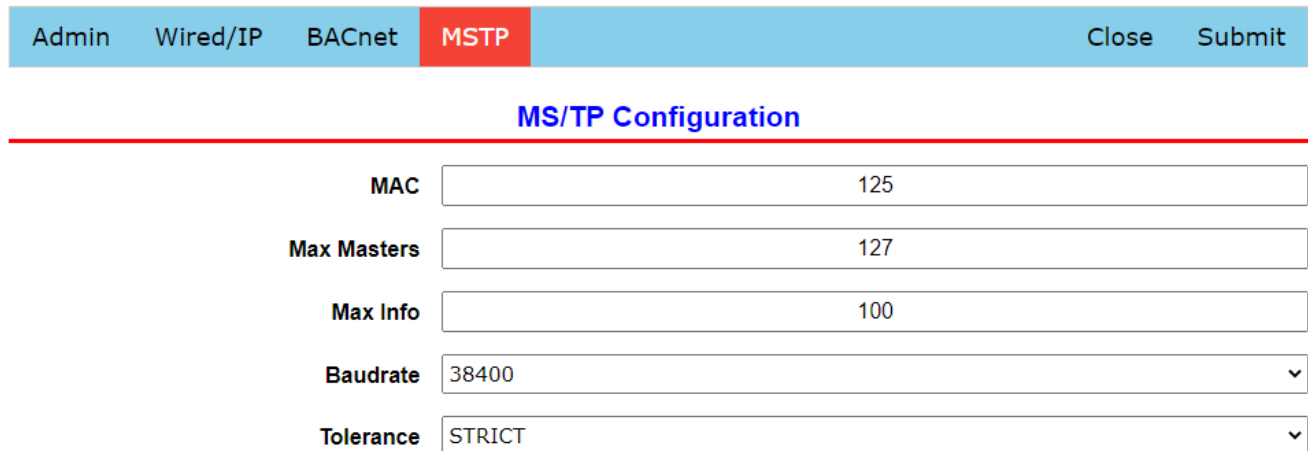

Parameter	Value
MAC	125
Max Masters	127
Max Info	100
Baudrate	38400
Tolerance	STRICT

Figure 25 — MS/TP Configuration Window for the BASC-22WSR

- **MAC Address** The MAC address must be a unique 8-bit (0–127) value in decimal that does not conflict with other MAC addresses on the connected network. Lower MAC address numbers are preferred. To optimize token passing and data exchange, it is also recommended that all other BACnet devices attached to the same MS/TP network be assigned consecutive MAC addresses beginning with 1 without any gaps in addressing.
- **Max Masters** Only master nodes participate in the MS/TP token-passing process and Max Masters must equal or exceed the highest MAC address for any master present on the network. The highest master MAC address (in decimal) in the MS/TP network is 127, and you should use 127 if you are unsure of other MS/TP device addresses. Each MS/TP device should use this same value. Since many BACnet devices do not allow this parameter to be changed, Max Master value of 127 is universal and will ensure a working network.
- **Max Info** Max Info is the maximum number of messages that can be exchanged onto the MS/TP network by the controller per token pass. Its range is 1–100, and the typical value is 100. The default value provides good performance, especially if the BACnet client is reading/writing values directly from the BACnet MS/TP network.
- **Baud Rate** The baud rate of the MS/TP network can be 9.6, 19.2, 38.4, 57.6, 76.8, or 115.2 kbps. All MS/TP devices on the same MS/TP network must use the same baud rate for successful communication.
- **Tolerance** This setting determines the degree to which interoperability with devices is successful. The LENIENT option is less efficient for traffic flow but optimizes interoperability and therefore is chosen as default. When using LENIENT, the controller will wait longer for devices to respond to a poll for master request. A slight improvement in performance will be realized by selecting the STRICT setting provided that the network is optimized, and other devices are able to respond in time.

5.3.2 System Status

From the BAScontrol22 Main Page, click the **System Status** button to open the System Status window and review:

- **Firmware Revision** Your firmware version of the controller.
- **MAC Address** The controller's Ethernet MAC address.
- **Available Memory** This amount of available Sedona application memory.
- **System Message Log** Useful for Contemporary Controls' troubleshooting.

Various items are reported in the System message Log after a power up cycle. Information is used by technical support at Contemporary Controls. The information can be cleared by clicking the **Clear Message Log** button. To refresh the page, click **Refresh Log**. Click **Close** to close the window.

System Status

Firmware Revision 4.0.1.31	MAC Address 00:50:DB:02:9E:E5	Available Memory 35704
--------------------------------------	---	----------------------------------

System Message Log

```
BAScontrol22W : 4.0.1.31 : Jun 23 2022 : 16:01:06
Free memory: 95920
Watchdog timer enabled
MAC=00:50:DB:02:9E:E5
Modbus disabled in configuration
Low memory limit= 8192
Counting units and objects...done
Reading configuration data...done
Initializing BACnet data...done
Platform has switch; checking for emac configuration file
Initializing network
EMAC code revision: 5.0.3
IP Addr: 10.0.3.82
IP Mask: 255.255.240.0
linkThread: NETWORK LINK OK
IP Gate: 10.0.0.1
Start Responder...OK
Starting Modbus Polling Thread
SVM starting; 55416 bytes free
Running SVM in platform mode
Sedona VM 1.2.28
buildDate: Jun 23 2022 16:01:06
endian: little
```

Clear Message Log	Close	Refresh Log
-------------------	-------	-------------

Figure 26 — System Status Window

5.3.3 Set Time

From the BAScontrol22 Main Page, click the **Set Time** button to configure the following settings:

- **System Time** You can *read* the date and time or *manually* set them—**but only if you disable** the NTP option.
- **NTP Configuration** is discussed in Section 0.
- **DST Configuration** is discussed in Section 5.3.3.3.

System Time		NTP Configuration		
Year	<input type="text" value="2022"/>	<input checked="" type="checkbox"/> NTP Enabled		
Month	<input type="text" value="July"/>	NTP Server	<input type="text" value="pool.ntp.org"/>	
Day	<input type="text" value="28"/>	Time Zone	<input type="text" value="Pacific:UTC-8"/>	
Hour	<input type="text" value="11 AM"/>	Refresh (Days)	<input type="text" value="1"/>	
Minute	<input type="text" value="6"/>	NTP Success		
<input type="button" value="Manual Time Set"/>		DST Configuration		
<input type="button" value="Refresh ON"/>		<input checked="" type="checkbox"/> DST Enabled		
		DST ON	DST OFF	
		Month	<input type="text" value="March"/>	<input type="text" value="November"/>
		Day of Month	<input type="text" value="2nd SUN"/>	<input type="text" value="1st SUN"/>
		Hour	<input type="text" value="2 AM"/>	<input type="text" value="2 AM"/>
<input type="button" value="Close"/>		<input type="button" value="Submit"/>		

Figure 27 — Set Time Window

5.3.3.1 Time of Day Retention

Time of Day is retained in an RTC with a super-cap backup allowing for temporary data retention in the event of a power loss. Not only does the RTC continue to keep time after a power loss, the data for virtual points VT01-VT08, the pulse input accumulators in UI1-UI4, and universal counters UC1, UC2, UC3, UC4 are also retained. The super-cap is derated as temperature increases. At the highest temperature rating of the BAScontrol22, retention is typically two days. At room temperature, retention could be at least seven days.

5.3.3.2 Configure System Time

System Time can be configured manually, or automatically by using the Network Time Protocol (NTP), or by receiving a BACnet TimeSync message. When configuring manually, or using NTP, there is an additional configuration for Daylight Savings Time (DST) correction. NTP does not account for summertime. When using BACnet TimeSync, DST correction is ignored assuming BACnet master timing is local time corrected for DST. The BAScontrol22 does not support UTC TimeSync.

- **NTP Enabled** Enable Network Time Protocol (disabled by default).
- **NTP Server** Change the default IP domain name (pool.ntp.org), if needed.
- **Time Zone** Set the Time Zone to match that of your location.
- **NTP Refresh (Days)** Change the default value (1) if needed.

NTP does not support local time zone changes such as for DST (Daylight Saving Time).

5.3.3.3 DST (Daylight Saving Time)

DST Configuration is provided because NTP cannot accommodate daylight saving time. With **DST Enabled**, drop-down menus allow you to set the date and time after midnight for enabling and disabling DST. Be sure to click **Submit** after making changes.

5.3.4 Web Components (WC01–WC48)

Web components allow you to interact with the Sedona wiresheet via a web browser versus using a Sedona tool. These are custom components developed by Contemporary Controls which are provided in the CControls_BASC22_Web kit. Configuring web components is accomplished using a Sedona tool by first setting the target component as an input or output (integer, float, or Boolean). In addition, high and low limits can be entered for wiresheet inputs. Returning to the web pages, for every web component (WC), a description and, in the case of inputs, a value can be entered. The **Description** field is only used to help the systems integrator understand the component’s function. If the component is configured as a wiresheet input, the assigned limits will restrict the range of the variable’s entry. This eliminates the need to add limit logic on the wiresheet. For wiresheet outputs, limits are ignored and not displayed. A green tag means that the web component has been placed on the wiresheet.

Web Components					
	Description	Value	Wire Sheet	Min	Max
WC01	Default Web Component 1	0	Input	0	100
WC02	Default Web Component 2	0	Input	0	100
WC03	Default Web Component 3	0	Input	0	100
WC04	Default Web Component 4	0	Input	0	100
WC05	Default Web Component 5	0	Input	0	100
WC06	Default Web Component 6	0	Input	0	100
WC07	Default Web Component 7	0	Input	0	100
WC08	Default Web Component 8	0	Input	0	100

Refresh OFF NOTE: A GREEN label indicates that the component has been placed on the wire sheet Close Submit

Figure 28 — Web Components Screen Showing Example Data

5.3.5 BACnet Utility

The built-in BACnet Utility allows for reading and writing of BACnet points throughout the BACnet internetwork. This can be very useful to test point reads/writes when integrating BACnet device points into the Sedona wiresheet. To access the BACnet Utility, click on the BACnet Utility button on the BAScontrol22 Main Page. When Custom is chosen in the Server dropdown menu, the Server Data and Object Data parameters are entered in manually after which the Read or Write buttons can be used to execute a respective command. Server Data parameters include Device Instance and Local IP address (or Device Instance, Router IP, Network, and MAC Address - for routed MS/TP devices). Object Data parameters include Object Type, Object Instance, and Object Property (such as Present Value).

If BACnet Server devices have been configured set up via the System Configuration -> BACnet web page, they will show up in the Server dropdown menu and their Server Data parameters (such as Device Instance and Local IP address, as shown in the figure) are populated automatically based on the setup in BACnet Configuration web page. The Object Data parameters can be selected, after which the Read or Write buttons can be used to execute a command. Polled value is shown in the Value field. Status of Success or Fail is printed in the Status field. For routed BACnet MS/TP devices to BACnet/IP, enter Router IP, Network number, and MAC Address to access BACnet server objects.

BACnet Utility

Server Data

Server: WAB091

Routed: MS/TP:

Device Instance: 900001

Local IP: 0.0.0.0

Object Data

Object Type: Analog Input

Object Instance: 1

Object Property: Present Value

Value: 77.5

Status: Success

Read Write

Figure 29a —BACnet Utility Window for the BASC-22WSR

BACnet Utility

Server Data

Server: WAB091

Routed: MS/TP:

Device Instance: 900001

MAC Address: 1

Object Data

Object Type: Analog Input

Object Instance: 1

Object Property: Present Value

Value: 77.5

Status: Success

Read Write

Close

Figure 29b —BACnet Utility Window for the BASC-22WSR with MS/TP selected

5.3.6 Restart Controller

Click the **Restart Controller** button to restart the BASC22 that is currently targeted by your browser. Extreme care should be exercised when resetting a commissioned controller.

5.3.7 Auto Refresh (On/Off)

Click the **Auto Refresh** button to update the BASC22 values currently displayed by your browser. With **Auto Refresh ON**, values periodically update. If **OFF**, there is no updating. Auto Refresh must be in the **OFF** state to make changes to the BAScontrol22 Main Page.

5.4 BAScontrol22 Main Web Page — Channel Configuration

Configure a real input/output channel from the BAScontrol22 Main Page. Click an input/output channel's linked heading to access its Channel Configuration screen. A large channel tag in the upper-right corner of the screen confirms the channel identity.

Note: Virtual input/output channels are configured via the **Virtual Points** button on the Main Page and will be discussed in Section 5.4.9.

The BAS Channel Configuration (upper) section of each configuration screen displays:

- **Channel Type** If more than one option is available, choose the desired type.
- **Channel Number** This *read-only* value confirms the selected channel.

Depending upon the type of input or output being configured, the channel selection options could change. Additional selections will appear based upon input/output type.

The BACnet Object Configuration (lower) section of each configuration screen displays:

- **Object Instance** This is the **read-only** value automatically assigned for this channel.
- **Object Name** Assign the channel a unique name, using up to 63 characters.
- **Object Type** This will match the selected Channel Type, except for Virtual Points which must be either Analog Value or Binary Value.
- **Object Description** Describe the device, using up to 63 characters.
- **Units** Choose the appropriate unit from the list of standard BACnet units.
- **COV Increment** Enter the amount of change (0 for any change) at which a COV message will be sent to subscribers. (Ignored for binary objects.) You can subscribe to 14 binary and 2 analog channels. Additional subscription requests will be denied.
- **Close button** The window closes whether the configuration is saved or not.
- **Submit button** This will immediately apply your configuration.

BAS Channel Configuration
U11

Channel Type

Temperature Offset

Temperature Units Out of Bounds Value

BACnet Object Configuration

Object Instance

Object Name

Object Type

Object Description

Units

COV Increment

Figure 30 — Sample Channel Configuration Screen

Clicking the **Submit** button registers your changes which become effective immediately. If you close the configuration screen without clicking the **Submit** button, ***your changes will be lost.***

Forcing I/O Points from the BAScontrol22 Main Page

There is one feature available on the BAScontrol22 Main Page that could be very useful for checkout and maintenance, but it must be done with great care. Both input and output points can be forced to states and values different from program generated values. From the Main Page, it is possible to both read and write values for the 22 real I/O points and 24 virtual points.

Just to the right of the value field is a checkbox. If you **hover your cursor** over this checkbox, this tool tip will display "Click to Force Channel." To change an input or output value, check this box before making a value change. This override value will remain until the checkbox is unchecked.

Caution: Use great care when forcing an input or output on a commissioned system to avoid damage to equipment or process or injury to personnel. The forced state will remain through a controller restart or power cycle.

5.4.1 Universal Input

5.4.1.1 Universal Input — Configured as Analog Input (Channels UI1–UI8)

To measure 0–10 V with UI1–UI8, click a linked heading from among UI1–UI8.

- Under BAS Channel Configuration, set the **Channel Type** to *Analog Input*. An example is shown in the figure below.
- Under BACnet Object Configuration, **Units** defaults to *VOLTS*. Change if necessary.
- Attach your device to the pair of BASC22 pins for the chosen channel so that the more positive connection is to pin A and the more negative to pin C.

The screenshot displays a web interface for configuring a Universal Input (UI1). It is divided into two main sections: "BAS Channel Configuration" and "BACnet Object Configuration".

BAS Channel Configuration:

- Channel Type:** A dropdown menu is set to "Analog Input".
- UI1:** The channel identifier "UI1" is displayed in the top right corner.

BACnet Object Configuration:

- Object Instance:** A text input field containing the value "1".
- Object Name:** A text input field containing the value "Universal Input 1".
- Object Type:** A dropdown menu set to "Analog Input".
- Object Description:** A text input field containing the value "Default BACnet Description".
- Units:** A dropdown menu set to "VOLTS".
- COV Increment:** A text input field containing the value "0".
- Buttons:** "Close" and "Submit" buttons are located at the bottom right of the configuration area.

Figure 31 — Universal Input Configured as Analog Input

5.4.1.2 Universal Input — Configured as Binary Input (Channels UI1–UI8)

To accept a binary input, click a linked heading from among UI1–UI8.

- Under BAS Channel Configuration, set the **Channel Type** to *Binary Input*.
- Under BACnet Object Configuration, set **Units** to *NO_UNITS*.
- Attach your device to the pair of BASC22 pins for the chosen channel so that the more positive connection is to pin A and the more negative to pin C.

The screenshot shows a web interface for configuring a BAS channel. It is divided into two main sections: "BAS Channel Configuration" and "BACnet Object Configuration".

BAS Channel Configuration:

- Channel Type:** A dropdown menu is set to "Binary Input".
- UI1:** A large blue label "UI1" is positioned to the right of the Channel Type dropdown.

BACnet Object Configuration:

- Object Instance:** A text input field containing the number "1".
- Object Name:** A text input field containing "Universal Input 1".
- Object Type:** A dropdown menu set to "Binary Input".
- Object Description:** A text input field containing "Default BACnet Description".
- Units:** A dropdown menu set to "NO_UNITS".
- COV Increment:** A text input field containing "0".
- Buttons:** "Close" and "Submit" buttons are located at the bottom right of the form.

Figure 32 — Universal Input Configured as Binary Input

5.4.1.3 Universal Input — Configured as Pulse Input (Channels UI1–UI4)

Any channel UI1–UI14 can be a **Pulse Input** for pulse trains in the range of 0–40 Hz. Pulse counting is retained in a non-volatile accumulator for up to eight days without power. The accumulator rollover is set by the **Maximum Value** field. To accept a pulse input, click a linked heading from among UI1–UI4.

- Under BAS Channel Configuration:
 - **Channel Type** — set to *Pulse Input*. Additional fields will appear.
Note: The BAS **Channel Type** is *Pulse Input*, but the BACnet **Object Type** is *Analog Input*. This is because the BACnet object is an accumulator.
 - **Maximum Value** — set the desired limit for the accumulated pulse count. It defaults to the absolute maximum of *16,777,215*. To **reset** the accumulator value to zero, momentarily set `Reset = true` in the universal input Sedona component using a Sedona Tool.
 - **Pull Up Resistor** — set to *Enabled*, if used with a passive device; otherwise set to *Disabled*.
- Under BACnet Object Configuration, set **Units** to what is appropriate for the pulse counting input. Pulse inputs can correspond to gallons per hour, kilowatts, etc., so they apply the appropriate BACnet unit for this channel. If there is a formula from the number of pulses to a real unit type, such as gallons per hour or kilowatts, then `NO_UNITS` is appropriate.

The image shows two configuration forms for channel UI1. The top form, titled "BAS Channel Configuration", has a "Channel Type" dropdown set to "Pulse Input". It includes input fields for "Maximum Value" (16777215), "High Threshold" (7.5), "Pull Up Resistor" (Enabled), and "Low Threshold" (2.5). The bottom form, titled "BACnet Object Configuration", has "Object Instance" set to 1, "Object Name" as "Universal Input 1", "Object Type" as "Analog Input", "Object Description" as "Default BACnet Description", "Units" as "NO_UNITS", and "COV Increment" as 0. "Close" and "Submit" buttons are at the bottom.

Figure 33 — Universal Input Configured as Pulse Input

5.4.1.4 Universal Input — Configured as Thermistor or Resistance Input (Channels UI1–UI8)

Channels UI1–UI8 can be used as Type II or Type III 10 k Ω thermistor inputs, a 20 k Ω thermistor input, 100 k Ω thermistor input, or a Resistance. (The 100 k Ω thermistor follows the Tasseron (PSB) curve.) The BACnet **Object Type** will be *Analog Input*.

To accept a thermistor input, click a linked heading from among UI1–UI8.

- Under BAS Channel Configuration:
 - **Channel Type** — set to *Therm 10kT2*, *Therm 10kT3*, *Therm 20k*, or *Therm 100k*. An example is shown in the figure below. Additional fields appear.
 - **Temperature Offset** — only used as needed. If you determine that your thermistor yields an inaccurate result, enter a positive or negative offset value to correct your thermistor reading.
 - **Temperature Units** — the *Fahrenheit* default can be changed to *Celsius*.
 - **Out of Bounds Value** — the temperature value you want assumed if an open or shorted thermistor condition occurs. A fault condition will be indicated in the universal input Sedona component.
- Under BACnet Object Configuration, set **Units** to Fahrenheit or Celsius to replicate the **Temperature Units** parameter.

The image shows a web-based configuration interface for a thermistor input. It is divided into two main sections: 'BAS Channel Configuration' and 'BACnet Object Configuration', both separated by red horizontal lines. The 'BAS Channel Configuration' section includes a 'Channel Type' dropdown menu set to 'Therm 100K', a 'Temperature Offset' text input field with the value '0', a 'Temperature Units' dropdown menu set to 'Fahrenheit', and an 'Out of Bounds Value' text input field with the value '77'. The 'BACnet Object Configuration' section includes an 'Object Instance' text input field with the value '1', an 'Object Name' text input field with the value 'Universal Input 1', an 'Object Type' dropdown menu set to 'Analog Input', an 'Object Description' text input field with the value 'Default BACnet Description', a 'Units' dropdown menu set to 'DEGREES_FAHRENHEIT', and a 'COV Increment' text input field with the value '0'. At the bottom right of the 'BACnet Object Configuration' section, there are 'Close' and 'Submit' buttons. The label 'UI1' is displayed in blue text in the top right corner of the configuration area.

Figure 34 — Thermistor Input Configuration

To accept a resistance input, click a title link from among UI1–UI8.

- Under BAS Channel Configuration:
 - **Channel Type** — set to *Resistance*.
 - **Open Circuit Value** — This will be the value display under open circuit conditions.
- Under BACnet Object Configuration, set **Units** to *OHMS*.

5.4.2 Binary Inputs (Channels BI1–BI4)

To accept a binary input with any channel BI1—BI4 as follows, click a linked heading from among BI1-BI4.

- Under BAS Channel Configuration, the **Channel Type** should be *Binary Input* by default.
- Under the BACnet Object Configuration, Units defaults to *NO_UNITS*.
- Attach your device to the pair of BASC22 pins for the chosen channel so that the more positive connection is to pin A and the more negative to pin C.

The screenshot shows a web-based configuration interface. At the top, there is a blue header "BAS Channel Configuration" with a red underline. Below this, the "Channel Type" is set to "Binary Input" in a dropdown menu. To the right of this section, the channel identifier "BI1" is displayed in blue. A second blue header "BACnet Object Configuration" is also underlined in red. Below this, the "Object Instance" is set to "9". The "Object Name" field contains "Binary Input 1". The "Object Type" is set to "Binary Input" in a dropdown menu. The "Object Description" field contains "Default Binary Description". The "Units" dropdown menu is set to "NO_UNITS". The "COV Increment" field is set to "0". At the bottom right, there are two buttons: "Close" and "Submit".

Figure 35 — Binary Input Configuration

5.4.3 Analog Outputs (Channels AO1–AO4)

Voltage in the range of 0–10 VDC (with up to 4 mA of current) can be outputted by assigning analog outputs. Configure an output using a web browser. For DC voltage, the output voltage is applied to point A with respect to C (common).

Any channel AO1–AO4 can be used to provide an analog voltage output. The BACnet **Channel Type** will be *Analog Output*. To configure an analog output, click a linked heading from among AO1–AO4.

- Under BAS Channel Configuration,
 - **Channel Type** — should be *Analog Output* (read-only) by default.
 - **Default Value** — is a value used by the output, immediately after boot-up of the controller when Sedona logic or BACnet client have yet to command the output point. As soon as Sedona logic or a BACnet client write to the point, **Default Value** is no longer used by the output. When BACnet priorities 1 through 16 are all nullified, the output point will use **Default Value** set in the channel configuration web page of the output point. This value is also reported to BACnet as *Relinquish Default* but cannot be written to by BACnet clients. It can only be set from the channel's web page in the BAScontrol.
- Under BACnet Object Configuration, Units defaults to *VOLTS*.
- Attach your device to the pair of BASC22 pins for the chosen channel so that the more positive connection is to pin A and the more negative to pin C.

The screenshot shows a web interface for configuring an analog output. It is divided into two sections: "BAS Channel Configuration" and "BACnet Object Configuration".

BAS Channel Configuration:

- Channel Type:** Analog Output (dropdown menu)
- Default Value:** 0 (text input field)

BACnet Object Configuration:

- Object Instance:** 13 (text input field)
- Object Name:** HeatAnalogOutput (text input field)
- Object Type:** Analog Output (dropdown menu)
- Object Description:** Voltage Output (text input field)
- Units:** VOLTS (dropdown menu)
- COV Increment:** 0 (text input field)

At the bottom right, there are "Close" and "Submit" buttons. The channel identifier "AO1" is displayed in the top right corner.

Figure 36 — Analog Output Configuration

5.4.4 Binary Outputs (Channels BO1–BO6)

The BASC22 can provide six binary relay outputs. The voltage and current limits for relay units are 30 VAC/VDC and 2 A. Violating these limits could damage the BASC22 and void the warranty.

Relay channels can be used as contact closures for other devices. It is common for the BASC22 binary outputs to enable the coils of interposing relays which can carry larger currents and support switching higher voltages.

Any channel BO1–BO6 can be used to provide a binary output. The BACnet type will be *Binary Output*. To configure a binary output, click a linked heading from among BO1–BO6.

- Under BAS Channel Configuration:
 - **Channel Type** — will be *Relay Output* (read-only) by default.
 - **Default Value** — is a value used by the output, immediately after boot-up of the controller when Sedona logic or BACnet client have yet to command the output point. As soon as Sedona logic or a BACnet client write to the point, Default Value is no longer used by the output. When BACnet priorities 1 through 16 are all nullified, the output point will use *Default Value* set in the channel configuration web page of the output point. This value is also reported to BACnet as *Relinquish Default* but cannot be written to by BACnet clients. It can only be set from the channel's web page in the BAScontrol.
- Under BACnet Object Configuration:
 - **Units** — will default to *NO_UNITS*.
 - **Object Type** — will default to *Binary Output*.
- Attach your device to the pair of BASC22 pins for the chosen channel so connections are marked A and B to facilitate wiring documentation.

The screenshot shows a web interface for configuring a binary output channel. It is divided into two main sections: "BAS Channel Configuration" and "BACnet Object Configuration".

BAS Channel Configuration:

- Channel Type:** A dropdown menu set to "Relay Output".
- Default Value:** A text input field containing the value "0".

BACnet Object Configuration:

- Object Instance:** A text input field containing the value "17".
- Object Name:** A text input field containing the value "SfanEnable".
- Object Type:** A dropdown menu set to "Binary Output".
- Object Description:** A text input field containing the value "Binary Output".
- Units:** A dropdown menu set to "NO_UNITS".
- COV Increment:** A text input field containing the value "0".

At the bottom right of the configuration area, there are two buttons: "Close" and "Submit". The channel identifier "BO1" is displayed in blue text in the top right corner of the configuration area.

Figure 37 — Binary Output Configuration

5.4.5 Virtual Points (Channels VT01–VT24)

Virtual Points

<p style="color: blue; font-weight: bold; margin: 0;">OccupyViaNetwork</p> <p>VT01 <input style="width: 80px;" type="text" value="1"/> <input type="checkbox"/></p>	<p style="color: blue; font-weight: bold; margin: 0;">OccupyOvrDuration</p> <p>VT02 <input style="width: 80px;" type="text" value="120.000"/> <input type="checkbox"/></p>	<p style="color: blue; font-weight: bold; margin: 0;">NetOccCoolingSP</p> <p>VT03 <input style="width: 80px;" type="text" value="75.000"/> <input type="checkbox"/></p>
<p style="color: blue; font-weight: bold; margin: 0;">NetOccHeatingSP</p> <p>VT04 <input style="width: 80px;" type="text" value="70.000"/> <input type="checkbox"/></p>	<p style="color: blue; font-weight: bold; margin: 0;">UnocCoolingSetpoint</p> <p>VT05 <input style="width: 80px;" type="text" value="80.000"/> <input type="checkbox"/></p>	<p style="color: blue; font-weight: bold; margin: 0;">UnocHeatingSetpoint</p> <p>VT06 <input style="width: 80px;" type="text" value="55.000"/> <input type="checkbox"/></p>
<p style="color: blue; font-weight: bold; margin: 0;">MinDeadband</p> <p>VT07 <input style="width: 80px;" type="text" value="5.000"/> <input type="checkbox"/></p>	<p style="color: blue; font-weight: bold; margin: 0;">ShutdownViaNetwork</p> <p>VT08 <input style="width: 80px;" type="text" value="1"/> <input type="checkbox"/></p>	<p style="color: blue; font-weight: bold; margin: 0;">UseNetOccSetptSelect</p> <p>VT09 <input style="width: 80px;" type="text" value="0"/> <input type="checkbox"/></p>
<p style="color: blue; font-weight: bold; margin: 0;">VT10spare</p> <p>VT10 <input style="width: 80px;" type="text" value="0.000"/> <input type="checkbox"/></p>	<p style="color: blue; font-weight: bold; margin: 0;">VT11spare</p> <p>VT11 <input style="width: 80px;" type="text" value="0.000"/> <input type="checkbox"/></p>	<p style="color: blue; font-weight: bold; margin: 0;">HeatCool2pModeCmd</p> <p>VT12 <input style="width: 80px;" type="text" value="0"/> <input type="checkbox"/></p>
<p style="color: blue; font-weight: bold; margin: 0;">AutoManHC_EnumStatus</p> <p>VT13 <input style="width: 80px;" type="text" value="0.000"/> <input type="checkbox"/></p>	<p style="color: blue; font-weight: bold; margin: 0;">ZoneSetptWallsetter</p> <p>VT14 <input style="width: 80px;" type="text" value="71.000"/> <input type="checkbox"/></p>	<p style="color: blue; font-weight: bold; margin: 0;">ZoneTempWallSetter</p> <p>VT15 <input style="width: 80px;" type="text" value="70.000"/> <input type="checkbox"/></p>
<p style="color: blue; font-weight: bold; margin: 0;">EffectHeatingSetpoint</p> <p>VT16 <input style="width: 80px;" type="text" value="66.000"/> <input type="checkbox"/></p>	<p style="color: blue; font-weight: bold; margin: 0;">EffectCoolingSetpoint</p> <p>VT17 <input style="width: 80px;" type="text" value="71.000"/> <input type="checkbox"/></p>	<p style="color: blue; font-weight: bold; margin: 0;">HeatingDemand</p> <p>VT18 <input style="width: 80px;" type="text" value="0.000"/> <input type="checkbox"/></p>
<p style="color: blue; font-weight: bold; margin: 0;">CoolingDemand</p> <p>VT19 <input style="width: 80px;" type="text" value="0.000"/> <input type="checkbox"/></p>	<p style="color: blue; font-weight: bold; margin: 0;">PwrButtonLockout</p> <p>VT20 <input style="width: 80px;" type="text" value="0"/> <input type="checkbox"/></p>	<p style="color: blue; font-weight: bold; margin: 0;">ModeButtonLockout</p> <p>VT21 <input style="width: 80px;" type="text" value="0"/> <input type="checkbox"/></p>
<p style="color: blue; font-weight: bold; margin: 0;">FanButtonLockout</p> <p>VT22 <input style="width: 80px;" type="text" value="0"/> <input type="checkbox"/></p>	<p style="color: blue; font-weight: bold; margin: 0;">VT23spare</p> <p>VT23 <input style="width: 80px;" type="text" value="0"/> <input type="checkbox"/></p>	<p style="color: blue; font-weight: bold; margin: 0;">HeartbeatFromBMS</p> <p>VT24 <input style="width: 80px;" type="text" value="0"/> <input type="checkbox"/></p>

Auto Refresh OFF

NOTES:

1. A GREEN label means that the virtual point has been placed on the wire sheet. The label hover text indicates if the point is configured as "Read from Wire Sheet" or "Write to Wire Sheet"
2. Values for input virtual points VT01-V08 are kept in persistent memory and will remain unchanged through resets and power cycles. Output virtuals will be modified by Sedona logic.

Figure 38 — Virtual Points Screen

The 24 virtual points (VTs) have their own web page which can be accessed by clicking the **Virtual Points** button at the bottom of the Main Page. Virtual points allow communication to and from a BACnet client to the BASC22 wiresheet. Virtual points are usually setpoints, calculated data or status points without connection to real input/output points on the controller.

Data Retention

In addition to keeping time of day after a power loss, the RTC's super cap backup also retains data for virtual points VT01-VT08. The super-cap is derated as temperature increases. At the highest temperature rating of the BAScontrol22, retention is typically two days. At room temperature, retention could be at least seven days.

BAS Channel Configuration

Channel Type

Default Value

VT01

BACnet Object Configuration

Object Instance

Object Name

Object Type

 Read from wire sheet
 Write to wire sheet

Object Description

Units

COV Increment

A Sedona tool is required to place VT components from the CControls_BASC22_IO kit onto the wiresheet. To receive requests from a BACnet client, a VT is placed on the wiresheet with its wiresheet slot configured as “an input to wiresheet.” This would then automatically configure the channel type (ChnType) slot of the component to Float Input. To respond to client requests, place a second VT with its wiresheet slot configured as “output from wiresheet” which would automatically configure the channel type slot to Float Output.

Figure 39 — Virtual Points Configuration Screen

To configure a virtual point, click the **Virtual Points** button. From the Virtual Points web page, click the linked heading from among VT01–VT24.

- Under BACnet Object Configuration
 - **Object Type** — set to Analog Variable or Binary Variable
 - **Object Name** — enter a unique name, up to 63 characters
 - **Object Description** — optional
 - **Units** — optional

Notice that the radio button **Read from Wiresheet** or **Write to Wiresheet** reflects the point of view of the BACnet client. This can only be changed by the Sedona tool.

The first eight virtual points (VT01–VT08) reside in persistent memory for up to seven days when power is removed. The remaining points are not retentive. A GREEN tag means that the virtual point has been placed on the wiresheet. Detailed information on configuring virtual components and using these custom Sedona components can be found in the appendix.

6 Appendix

6.1 List of Installed Sedona Kits

Sedona Component Kit Name	BASC-22DR	BASC-22SR	BASC-22WR	BASC-22WSR
CControls_BASCC_NETV	√	√	√	√
CControls_BASC22D_IO	√			
CControls_BASC22D_Platform	√			
CControls_BASC22D_Web	√	√		
CControls_BASC22S_Platform		√		
CControls_BASC22S_Web		√		
CControls_BASC22WR_IO			√	
CControls_BASC22WR_Platform			√	
CControls_BASC22WR_Web			√	
CControls_BASCC_WS			√	√
CControls_BASC22WS_IO				√
CControls_BASC22WS_Platform				√
CControls_BASC22WS_Web				√
basicSchedule	√	√	√	√
datetimeStd	√	√	√	√
func	√	√	√	√
hvac	√	√	√	√
logic	√	√	√	√
math	√	√	√	√
pricomp	√	√	√	√
sys	√	√	√	√
timing	√	√	√	√
types	√	√	√	√
CControls_Function	√	√	√	√
CControls_Function2	√	√	√	√
CControls_Math	√	√	√	√
CControls_Math2	√	√	√	√
CControls_HVAC	√	√	√	√
CControls_P_HVAC2	√	√	√	√

6.2 Wall Setter Option

The BASC-22WS and BASC-22WSR support a wall setter option. This four-wire powered serial port connection can accommodate one Contemporary Controls' BASWS-M wall setter. The wall setter has a large LCD display with programmable numeric characters and icons to show mode of operation, setpoint and measured variable. A five-button pad provides mode control and navigation. Although the BASWS-M is a general-purpose wall setter, its operation with the BASC22 depends upon custom Sedona components that interface the wall setter's serial port connection to Sedona wiresheet logic. If the wall setter model is being used with a Contemporary Controls' pre-built application, there is no need to configure the wall setter during installation. The default settings of the wall setter should be sufficient.

The unit has a built-in space temperature sensor. Either the setpoint or the measured variable can be displayed in units of Celsius or Fahrenheit. Depressing the up or down arrows will display the setpoint along with the thermometer icon indicating to the operator that the display is the setpoint. After a short timeout, the display will return to the space temperature and the thermometer icon will disappear. The operation of the fan button can vary based upon wiresheet logic. The power button forces the application in idle state with the display indicating OFF

The five buttons on the wall setter should be treated as inputs. Depending upon wiresheet logic, these buttons can be enabled or disabled.

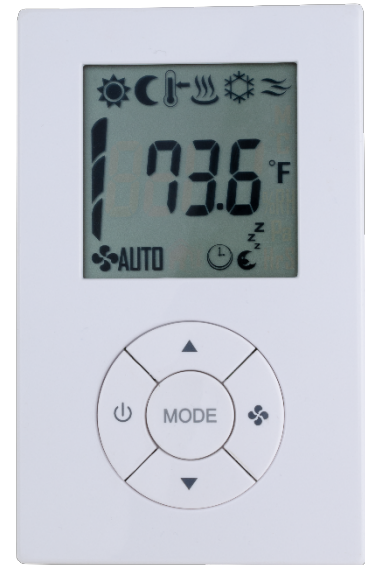







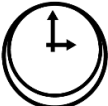



Figure 40 — BASWS-M Wall Setter

Input Button	Use
Mode button	Sedona logic will determine specific modes
Up arrow button	Increase setpoint manually
Down arrow button	Decrease setpoint manually
Fan button	Sedona logic will determine fan mode and/or speed
On/Off button	Enter idle state while displaying OFF

All icons can be programmed to be disabled, enabled or to flash. The significance of the icon state is determined by the custom Sedona components and pre-built application. When On/Off button is Off, all icons are automatically disabled. Consult the Contemporary Controls' BAScontrol Applications manual for detailed operation of buttons and icons.

Icons should be treated as outputs. Icons can be on, off, or flash giving the added significance to the state of the application. What follows are the meanings of their various states of each icon.

Icon Output	Name	Meaning or State
	Sun	In occupied mode, the icon is solid. In unoccupied mode, the icon is off. In temporary occupied mode the icon is solid.
	Moon	In occupied mode or temporary occupied mode, the icon is off. In unoccupied mode, the icon is solid.
	Thermometer	The icon appears when set point is displayed otherwise it is off.
	Flame	The icon is solid in heating mode, and flashes if there is a call for heating in either automatic or manual modes.
	Snowflake	The icon is solid in cooling mode, and flashes if there is a call for cooling in either automatic or manual modes.
	Wind	The icon is solid in ventilation mode when there is no call for heating or cooling, but the fan is on, and the building is in occupied mode; otherwise, it is off.
	Fan	The icon is solid when in Manual Fan mode. The icon flashes when the fan is running if fan status feedback logic is used.
	Auto	The icon is solid when in Auto Fan mode. The icon is disabled when in Manual Fan mode or if fan is set by logic to run continuously during occupied mode.
	Clock	The icon will flash if the wall setter is in temporary occupied mode otherwise, it is off.
	Sleep	The icon is solid if the wall setter is in standby mode having no outputs commanded on.
	Fan Speed	For multi-speed fan applications, this three-segment icon can be used to display one, two, or three segments. It can be disabled for single-fan speed applications.

6.3 Protocol Implementation Conformance Statements (PICS)

BASC-22DR



BAScontrol22D

BACnet/IP Sedona Unitary Controller



BACnet Protocol Implementation Conformance Statement (Annex A)

Date: May 12, 2022
Vendor Name: Contemporary Controls
Product Name: BAScontrol22D
Product Model Number: BASC-22DR
Applications Software Version: 1.2.28 **Firmware Revision:** 4.0.2 **BACnet Protocol Revision:** 15
Product Description: BACnet/IP compliant 22-point field controller or remote I/O that allows a direct connection to Ethernet without the need of a BACnet router.

BACnet Standardized Device Profile (Annex L):

- BACnet Operator Workstation (B-OWS)
- BACnet Building Controller (B-BC)
- BACnet Advanced Application Controller (B-AAC)
- BACnet Application Specific Controller (B-ASC)
- BACnet Smart Sensor (B-SS)
- BACnet Smart Actuator (B-SA)

List all BACnet Interoperability Building Block Supported (Annex K):

- DS-RP-B Data Sharing — ReadProperty — A, B
- DS-WP-B Data Sharing — WriteProperty — A, B
- DS-RPM-B Data Sharing — ReadPropertyMultiple — B
- DS-COV-B Data Sharing — ChangeOfValue — B
- DM-DDB-B Device Management — Dynamic Device Binding — B
- DM-DOB-B Device Management — Dynamic Object Binding — B
- DM-DCC-B Device Management — Device Communication Control — B
- DM-TS-B Device Management — Time Synchronization — B

Segmentation Capability:

- Able to transmit segmented messages Window Size:
- Able to receive segmented messages Window Size:

Standard Object Types Supported:

Object Type Supported	Can Be Created Dynamically	Can Be Deleted Dynamically
Analog Input	No	No
Analog Output	No	No
Analog Value	No	No
Binary Input	No	No
Binary Output	No	No
Binary Value	No	No
Device	No	No

No optional properties are supported.

Data Link Layer Options:

- BACnet IP, (Annex J)
- BACnet IP, (Annex J), Foreign Device
- ISO 8802-3, Ethernet (Clause 7)
- ANSI/ATA 878.1, EIA-485 ARCNET (Clause 8), baud rate(s):
- MS/TP master (Clause 9), baud rate(s):
- MS/TP slave (Clause 9), baud rate(s):
- Point-To-Point, EIA 232 (Clause 10), baud rate(s):
- Point-To-Point, modem, (Clause 10), baud rate(s):
- LonTalk, (Clause 11), medium:
- Other:

Device Address Binding:

Is static device binding supported? (This is currently necessary for two-way communication with MS/TP slaves and certain other devices.) Yes No

Networking Options:

- Router, Clause 6 — List all routing configurations, e.g., ARCNET-Ethernet-MS/TP, etc.
- Annex H, BACnet Tunnelling Router over IP
- BACnet/IP Broadcast Management Device (BBMD)
- Does the BBMD support registrations by Foreign Devices? Yes No

Character Sets Supported:

Indicating support for multiple character sets does not imply that they can all be supported simultaneously.

- ANSI X3.4
- ISO 10646 (UCS-2)
- IBM™ /Microsoft™ DBCS
- ISO 10646 (UCS-4)
- ISO 8859-1
- JIS C 6226

If this product is a communication gateway, describe the types of non-BACnet equipment/network(s) that the gateway supports:
 No gateway support.



BAScontrol22S
BACnet/IP Sedona Unitary Controller

BACnet Protocol Implementation Conformance Statement (Annex A)

Date: May 12, 2022
Vendor Name: Contemporary Controls
Product Name: BAScontrol22S
Product Model Number: BASC-22SR
Applications Software Version: 1.2.28 **Firmware Revision:** 4.0.2 **BACnet Protocol Revision:** 15
Product Description: BACnet/IP compliant 22-point field controller or remote I/O that allows a direct connection to Ethernet without the need of a BACnet router. Also has support for MS/TP communications.

- BACnet Standardized Device Profile (Annex L):**
- BACnet Operator Workstation (B-OWS)
 - BACnet Building Controller (B-BC)
 - BACnet Advanced Application Controller (B-AAC)
 - BACnet Application Specific Controller (B-ASC)
 - BACnet Smart Sensor (B-SS)
 - BACnet Smart Actuator (B-SA)

- List all BACnet Interoperability Building Block Supported (Annex K):**
- DS-RP-B Data Sharing — ReadProperty — A, B
 - DS-WP-B Data Sharing — WriteProperty — A, B
 - DS-RPM-B Data Sharing — ReadPropertyMultiple — B
 - DS-COV-B Data Sharing — ChangeOfValue — B
 - DM-DDB-B Device Management — Dynamic Device Binding — B
 - DM-DOB-B Device Management — Dynamic Object Binding — B
 - DM-DCC-B Device Management — Device Communication Control — B
 - DM-TS-B Device Management — Time Synchronization — B

- Segmentation Capability:**
- Able to transmit segmented messages Window Size:
 - Able to receive segmented messages Window Size:

Standard Object Types Supported:

Object Type Supported	Can Be Created Dynamically	Can Be Deleted Dynamically
Analog Input	No	No
Analog Output	No	No
Analog Value	No	No
Binary Input	No	No
Binary Output	No	No
Binary Value	No	No
Device	No	No

No optional properties are supported.

Data Link Layer Options:

- BACnet IP, (Annex J)
- BACnet IP, (Annex J), Foreign Device
- ISO 8802-3, Ethernet (Clause 7)
- ANSI/ATA 878.1, EIA-485 ARCNET (Clause 8), baud rate(s):
- MS/TP master (Clause 9), baud rate(s): 9.6,19.2,38.6, 57.6, 76.8, 115.2 kbps
- MS/TP slave (Clause 9), baud rate(s):
- Point-To-Point, EIA 232 (Clause 10), baud rate(s):
- Point-To-Point, modem, (Clause 10), baud rate(s):
- LonTalk, (Clause 11), medium:
- Other:

Device Address Binding:

Is static device binding supported? (This is currently necessary for two-way communication with MS/TP slaves and certain other devices.) Yes No

Networking Options:

- Router, Clause 6 – List all routing configurations, e.g., ARCNET-Ethernet-MS/TP, etc.
- Annex H, BACnet Tunnelling Router over IP
- BACnet/IP Broadcast Management Device (BBMD)
- Does the BBMD support registrations by Foreign Devices? Yes No

Character Sets Supported:

Indicating support for multiple character sets does not imply that they can all be supported simultaneously.

- ANSI X3.4
- IBM™/Microsoft™ DBCS
- ISO 8859-1
- ISO 10646 (UCS-2)
- ISO 10646 (UCS-4)
- JIS C 6226

If this product is a communication gateway, describe the types of non-BACnet equipment/network(s) that the gateway supports:
 No gateway support.



BAScontrol22W
BACnet/IP Sedona Unitary Controller



BACnet Protocol Implementation Conformance Statement (Annex A)

Date: May 12, 2022
Vendor Name: Contemporary Controls
Product Name: BAScontrol22W
Product Model Number: BASC-22WR
Applications Software Version: 1.2.28 **Firmware Revision:** 4.0.2 **BACnet Protocol Revision:** 15
Product Description: BACnet/IP compliant 22-point field controller or remote I/O that allows a direct connection to Ethernet without the need of a BACnet router. Supports communications to proprietary wall setter.

BACnet Standardized Device Profile (Annex L):

- BACnet Operator Workstation (B-OWS)
- BACnet Building Controller (B-BC)
- BACnet Advanced Application Controller (B-AAC)
- BACnet Application Specific Controller (B-ASC)
- BACnet Smart Sensor (B-SS)
- BACnet Smart Actuator (B-SA)

List all BACnet Interoperability Building Block Supported (Annex K):

- DS-RP-B Data Sharing — ReadProperty – A, B
- DS-WP-B Data Sharing — WriteProperty – A, B
- DS-RPM-B Data Sharing — ReadPropertyMultiple – B
- DS-COV-B Data Sharing — ChangeOfValue – B
- DM-DDB-B Device Management — Dynamic Device Binding – B
- DM-DOB-B Device Management — Dynamic Object Binding – B
- DM-DCC-B Device Management — Device Communication Control – B
- DM-TS-B Device Management — Time Synchronization – B

Segmentation Capability:

- Able to transmit segmented messages Window Size:
- Able to receive segmented messages Window Size:

Standard Object Types Supported:

Object Type Supported	Can Be Created Dynamically	Can Be Deleted Dynamically
Analog Input	No	No
Analog Output	No	No
Analog Value	No	No
Binary Input	No	No
Binary Output	No	No
Binary Value	No	No
Device	No	No

No optional properties are supported.

Data Link Layer Options:

- BACnet IP, (Annex J)
- BACnet IP, (Annex J), Foreign Device
- ISO 8802-3, Ethernet (Clause 7)
- ANSI/ATA 878.1, EIA-485 ARCNET (Clause 8), baud rate(s):
- MS/TP master (Clause 9), baud rate(s):
- MS/TP slave (Clause 9), baud rate(s):
- Point-To-Point, EIA 232 (Clause 10), baud rate(s):
- Point-To-Point, modem, (Clause 10), baud rate(s):
- LonTalk, (Clause 11), medium:
- Other:

Device Address Binding:

Is static device binding supported? (This is currently necessary for two-way communication with MS/TP slaves and certain other devices.) Yes No

Networking Options:

- Router, Clause 6 – List all routing configurations, e.g., ARCNET-Ethernet-MS/TP, etc.
 - Annex H, BACnet Tunnelling Router over IP
 - BACnet/IP Broadcast Management Device (BBMD)
- Does the BBMD support registrations by Foreign Devices? Yes No

Character Sets Supported:

Indicating support for multiple character sets does not imply that they can all be supported simultaneously.

- ANSI X3.4
- IBM™/Microsoft™ DBCS
- ISO 8859-1
- ISO 10646 (UCS-2)
- ISO 10646 (UCS-4)
- JIS C 6226

If this product is a communication gateway, describe the types of non-BACnet equipment/network(s) that the gateway supports:
 No gateway support.



BAScontrol22WS

BACnet/IP Sedona Unitary Controller



BACnet Protocol Implementation Conformance Statement (Annex A)

Date: May 12, 2022
Vendor Name: Contemporary Controls
Product Name: BAScontrol22WS
Product Model Number: BASC-22WSR
Applications Software Version: 1.2.28 **Firmware Revision:** 4.0.2 **BACnet Protocol Revision:** 15
Product Description: BACnet/IP compliant 22-point field controller or remote I/O that allows a direct connection to Ethernet without the need of a BACnet router. Supports communications to proprietary wall setter. Also has support for MS/TP communications.

- BACnet Standardized Device Profile (Annex L):**
- BACnet Operator Workstation (B-OWS)
 - BACnet Building Controller (B-BC)
 - BACnet Advanced Application Controller (B-AAC)
 - BACnet Application Specific Controller (B-ASC)
 - BACnet Smart Sensor (B-SS)
 - BACnet Smart Actuator (B-SA)

- List all BACnet Interoperability Building Block Supported (Annex K):**
- DS-RP-B Data Sharing — ReadProperty — A, B
 - DS-WP-B Data Sharing — WriteProperty — A, B
 - DS-RPM-B Data Sharing — ReadPropertyMultiple — B
 - DS-COV-B Data Sharing — ChangeOfValue — B
 - DM-DDB-B Device Management — Dynamic Device Binding — B
 - DM-DOB-B Device Management — Dynamic Object Binding — B
 - DM-DCC-B Device Management — Device Communication Control — B
 - DM-TS-B Device Management — Time Synchronization — B

- Segmentation Capability:**
- Able to transmit segmented messages Window Size:
 - Able to receive segmented messages Window Size:

Standard Object Types Supported:

Object Type Supported	Can Be Created Dynamically	Can Be Deleted Dynamically
Analog Input	No	No
Analog Output	No	No
Analog Value	No	No
Binary Input	No	No
Binary Output	No	No
Binary Value	No	No
Device	No	No

No optional properties are supported.

Data Link Layer Options:

- BACnet IP, (Annex J)
- BACnet IP, (Annex J), Foreign Device
- ISO 8802-3, Ethernet (Clause 7)
- ANSI/ATA 878.1, EIA-485 ARCNET (Clause 8), baud rate(s):
- MS/TP master (Clause 9), baud rate(s): 9.6, 19.2, 38.4, 57.6, 76.8, 115.2 kbps
- MS/TP slave (Clause 9), baud rate(s):
- Point-To-Point, EIA 232 (Clause 10), baud rate(s):
- Point-To-Point, modem, (Clause 10), baud rate(s):
- LonTalk, (Clause 11), medium:
- Other:

Device Address Binding:

Is static device binding supported? (This is currently necessary for two-way communication with MS/TP slaves and certain other devices.) Yes No

Networking Options:

- Router, Clause 6 – List all routing configurations, e.g., ARCNET-Ethernet-MS/TP, etc.
 - Annex H, BACnet Tunnelling Router over IP
 - BACnet/IP Broadcast Management Device (BBMD)
- Does the BBMD support registrations by Foreign Devices? Yes No

Character Sets Supported:

- Indicating support for multiple character sets does not imply that they can all be supported simultaneously.
- ANSI X3.4
 - IBM™ /Microsoft™ DBCS
 - ISO 8859-1
 - ISO 10646 (UCS-2)
 - ISO 10646 (UCS-4)
 - JIS C 6226

If this product is a communication gateway, describe the types of non-BACnet equipment/network(s) that the gateway supports:

No gateway support.

**United States
Contemporary Control
Systems, Inc.**

Tel: +1-630-963-7070
Fax: +1-630-963-0109

info@ccontrols.com

**China
Contemporary Controls
(Suzhou) Co. Ltd**

Tel: +86 512 68095866
Fax: +86 512 68093760

info@ccontrols.com.cn

**United Kingdom
Contemporary Controls
Ltd**

Tel: +44 (0)24 7641 3786
Fax: +44 (0)24 7641 3923

ccl.info@ccontrols.com

**Germany
Contemporary Controls
GmbH**

Tel: +49 341 520359 0
Fax: +49 341 520359 16

ccg.info@ccontrols.com

www.ccontrols.com

CONTEMPORARY CONTROLS®

April 2023