

# iSMA-B-40-H

SPECIFICATION			
Supply	DC: 24 V ± 20%, 1.6 W; AC: 24 V ± 20%, 2.4 VA		
Digital Outputs	4x relay output	Maximum ratings	UL compliant ratings
	Resistive load max.	8 A @ 230 V AC 8 A @ 30 V DC	8 A @ 24 V AC 8 A @ 30 V DC
	Inductive load max.	360 VA @ 230 V AC 90 W @ 30 V DC	37 VA @ 24 V AC 90 W @ 30 V DC
Interface	RS485 half-duplex, Modbus or BACnet, up to 128 devices on the bus		
Address	Set by switch in range from 0 to 99		
Baudrate	Set by switch in range from 4800 to 115200 bps		
Ingress Protection Rating	IP40 - for indoor installation		
Temperature	Operating: -10°C to +50°C (14°F to 122°F) Storage: -40°C to +85°C (-40°F to 185°F)		
Relative humidity	5 to 95% RH (without condensation)		
Connectors	Separable, max 2.5 mm <sup>2</sup> (18 – 12 AWG)		
Dimension	37x110x62 mm (1.45x4.33x2.44 in)		
Mounting	DIN rail mounting (DIN EN 50022 norm)		
Housing material	Plastic, self-extinguishing PC/ABS		

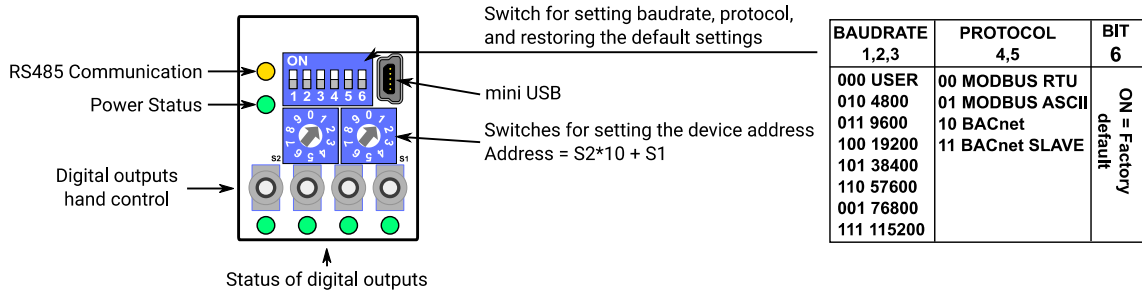

## TOP PANEL



## DIGITAL OUTPUTS

### Connection of electrovalve

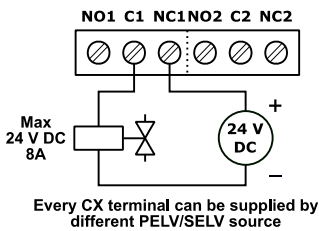

### Connection of resistive load

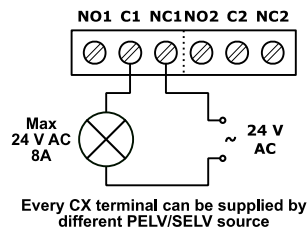

### Connection of inductive load

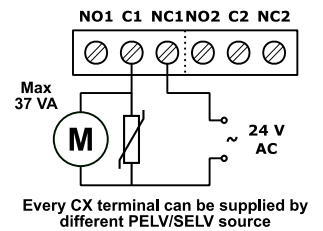

## COMMUNICATION

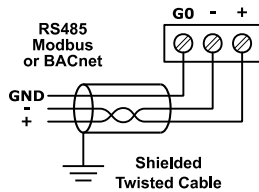

## POWER SUPPLY

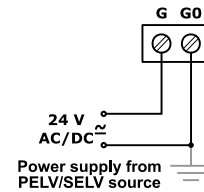

## WARNING

- Note, an incorrect wiring of this product can damage it and lead to other hazards. Make sure the product has been correctly wired before turning the power ON.
- Before wiring, or removing/mounting the product, be sure to turn the power OFF. Failure to do so might cause electric shock.
- Do not touch electrically charged parts such as the power terminals. Doing so might cause electric shock.
- Do not disassemble the product. Doing so might cause electric shock or faulty operation.
- Use the product within the operating ranges recommended in the specification (temperature, humidity, voltage, shock, mounting direction, atmosphere etc.). Failure to do so might cause fire or faulty operation.
- Firmly tighten the wires to the terminal. Insufficient tightening of the wires to the terminal might cause fire.

## TERMINALS OF THE DEVICE

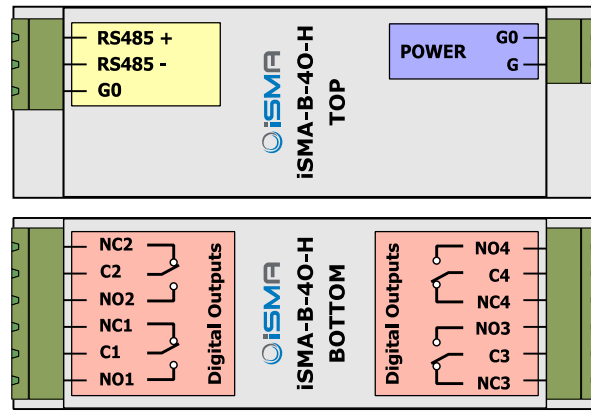

All G0 terminals are connected together internally

## EN 60730-1 POWER SUPPLY CONSIDERATIONS

- Electrical safety in the building automation and control systems is essentially based on the use of extra low voltage which is strictly separated from the mains voltage. This low voltage is either SELV or PELV according to EN 60730-1.
- Protection against electric shock is ensured by the following measures:
  - limitation of voltage (low voltage AC/DC 24V supply, either SELV or PELV)
  - protective-separation of the SELV-system from all circuits other than SELV and PELV
  - simple-separation of the SELV-system from other SELV-systems, from PELV-systems and earth
- Field devices such as sensors, status contacts and actuators connected to the low-voltage inputs and outputs of I/O modules must comply with the requirements for SELV or PELV. The interfaces of field devices and other systems must also satisfy SELV or PELV requirements.
- When the supply of SELV or PELV circuits is obtained from supply mains of higher voltages it shall be provided by safety transformer or a converter designed for continuous operation to supply SELV or PELV circuits.

## FCC COMPLIANCE NOTE

Note: This equipment has been tested and found to comply with the limits for a Class B digital device, pursuant to part 15 of the FCC Rules. These limits are designed to provide reasonable protection against harmful interference in a residential installation. This equipment generates, uses and can radiate radio frequency energy and, if not installed and used in accordance with the instructions, may cause harmful interference to radio communications. However, there is no guarantee that interference will not occur in a particular installation. If this equipment does cause harmful interference to radio or television reception, which can be determined by turning the equipment off and on, the user is encouraged to try to correct the interference by one or more of the following measures:

- Reorient or relocate the receiving antenna.
- Increase the separation between the equipment and receiver.
- Connect the equipment into an outlet on a circuit different from that to which the receiver is connected.
- Consult the dealer or an experienced radio/TV technician for help.

## WIRING

- Line power cables must be routed with spatial separation from signal and data transmission cables.
- Analogue and digital signal cables should also be separated.
- It is recommended to use shielded cables for analogue signals, cable shields should not be interrupted by intermediate terminals.
- The shielding should be earthed directly after the cable enters the cabinet.
- It is recommended to install interference suppressors when switching inductive loads (e.g. coils of contactors, relays, solenoid valves). RC snubbers or varistors are suitable for AC voltage and freewheeling diodes for DC voltage loads. The suppressing elements must be connected as close to the coil as possible