

# application NOTE



## Creating a Web-based Thermostat Using the BAScontrol20

### Introduction

The BAScontrol20 is a BACnet/IP (B-ASC) freely-programmable Sedona Framework direct digital controller (DDC) and therefore has the flexibility to implement any number of control schemes. Using Niagara Workbench connected to the BAScontrol20's Ethernet port; the systems integrator can personalize the BAScontrol20 by dragging and dropping Sedona components onto a wire sheet. Using "soft wires" called links to interconnect components; an application program is created meeting the requirements of the project. Anyone with knowledge of Niagara Framework would be comfortable with the

process. Those with just a basic knowledge of Sedona Framework would benefit from knowing how this process is accomplished. To demonstrate the BAScontrol20's flexibility, this application note describes the process of creating an application called a Web Thermostat using both standard and custom Sedona components and web pages. The only assumption is that the systems integrator knows how to utilize the Niagara Workbench tool to program the BAScontrol20 through its Ethernet port and has access to a web browser.

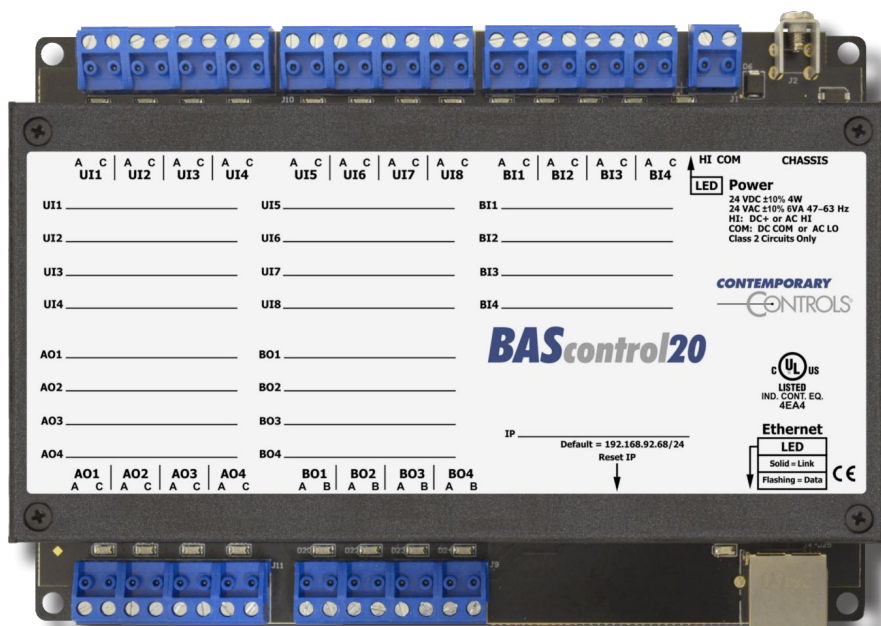

The BAScontrol20 has eight universal inputs, four binary inputs, four analog outputs and four binary outputs.

**BASautomation**®

## BAScontrol20 — Overview

The BAScontrol20 utilizes a powerful 32-bit ARM7 processor with 512 kB of flash memory plus a 16 Mbit serial flash file system for storing configuration data and an application program. By operating at the BACnet/IP level, the BAScontrol20 can share the same Ethernet network with supervisory controllers and operator workstations. The unit can be configured for a fixed IP address or can operate as a DHCP client receiving its IP address from a DHCP server. A real-time clock with a super-cap backup allows for creating local schedules.

A 10/100 Mbps Ethernet port supports protocols such as BACnet/IP, Sedona SOX, HTTP and FTP. Configuration of universal inputs and virtual points can be accomplished using web pages. Type II and type III thermistors curves are resident in the unit. Current inputs can be measured using external resistors. Contact closures require a voltage-free source. Binary inputs and outputs as well as analog outputs require no configuration. The unit is powered from a 24VAC/VDC source.

### Universal Inputs

Eight input points can be configured — all discoverable as BACnet objects.

- Analog inputs: 0–10 VDC, 12-bit resolution, 0–20 mA (with external resistor)
- Temperature inputs: Type II or Type III 10 kΩ thermistors
- Contact closure, voltage-free
- Pulse input accumulators (UI1–UI4): accommodates active or passive sources (40 Hz max)

### Binary Inputs

Four points of voltage-free contact closure

### Power Input

24 VAC/VDC 6 VA half-wave rectified allows power sharing with other half-wave devices.

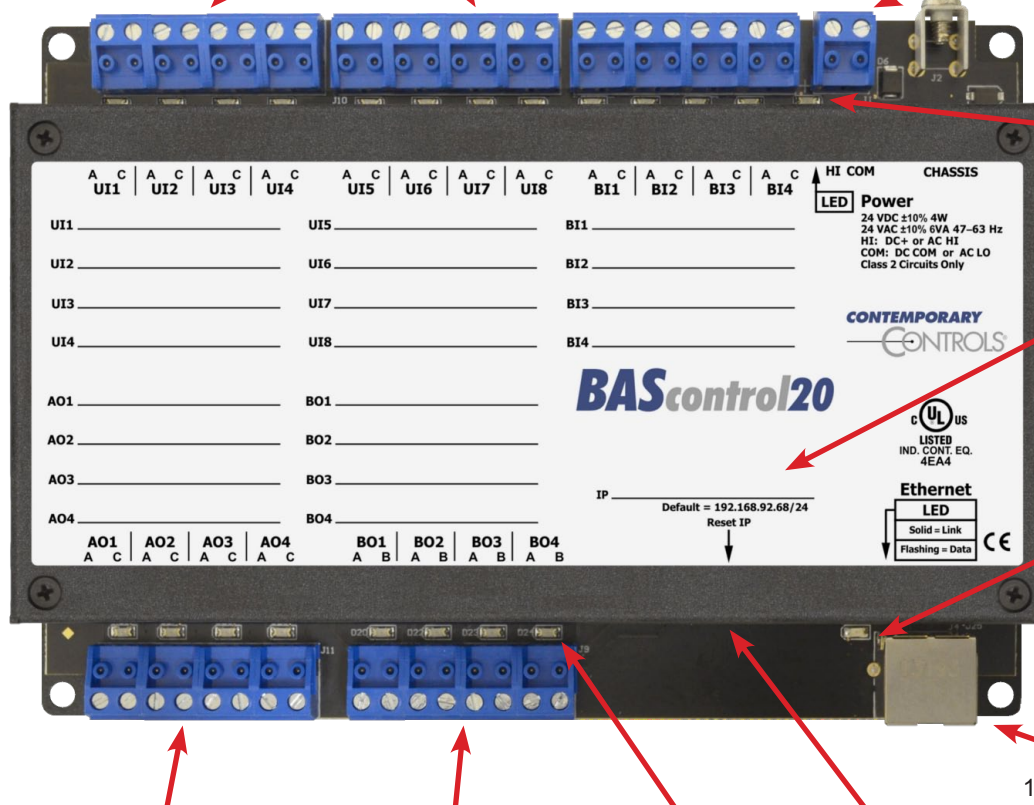

**Power LED**

**IP Address**  
fixed or  
DHCP client

**Ethernet LED**

### Analog Outputs

0–10 V, 12-bit resolution

### Binary Outputs

Four form “A” relays  
or four triacs for  
30 VAC/VDC 2 A loads.  
Class 2 circuits only.

### Point LEDs

for all 20 Points

### Reset

to factory  
IP defaults

### Ethernet

10/100 Mbps Ethernet with  
auto-negotiation and Auto-MDIX.  
Protocols supported include  
HTTP, IP, UDP, TCP, BACnet/IP  
and Sedona SOX.

## **Sequence of Operation for the Web Thermostat**

A Web Thermostat controls the operation of a single rooftop unit capable of single-stage heating or cooling. Desired occupied and unoccupied heating and cooling setpoints are programmed via a web page using a seven-day schedule. Cooling setpoints are automatically incremented by the deadband amount if a rise in the heating setpoint exceeds the deadband. Other operational parameters are set through a configuration web page. Fan operation is determined by the mechanical equipment or the state of the “Auto-On” fan mode switch. Heating and cooling operation as described herein assumes that the system “Heat-Auto-Cool-Off” operating mode is in the “Auto” state.

### **Occupied Mode**

When the Web Thermostat signifies occupied mode, the supply fan cycles upon a call for heating or cooling, as determined by the rooftop unit.

Upon a rise in space temperature above the occupied cooling setpoint, rooftop unit cooling is initiated and DX cooling is engaged. As the space temperature falls back toward setpoint, then the cooling stage disengages.

Upon a drop in space temperature below the occupied heating setpoint, rooftop unit heating is initiated. The gas-fired heating is engaged. As the space temperature rises back toward setpoint, then the heating stage disengages. Occupied heating setpoint is set higher than the unoccupied heating setpoint in the range between 60–80° F. Occupied cooling setpoint is set lower than unoccupied cooling setpoint in a range between 65–85° F.

### **Unoccupied Mode**

When the Web Thermostat signifies unoccupied mode, the supply fan cycles upon a call for heating or cooling, as determined by the rooftop unit.

Unoccupied heating setpoint is set lower than the occupied heating setpoint in the range between 60–80° F. Unoccupied cooling setpoint is set higher than occupied cooling setpoint in a range between 65–85° F. Rooftop unit heating and cooling operate as described above in Occupied Mode, except as to maintain the unoccupied heating and cooling setpoints.

### **Fan Mode**

Regardless of operating mode, when the fan mode is set to “On” the fan will run continuously. With the fan mode at “Auto” the mechanical equipment controls the fan.

### **Operating Limits**

The absolute maximum heating setpoint is adjustable but cannot exceed 90° F. The absolute minimum cooling setpoint is also adjustable but cannot be lower than 54° F. If frost protection is enabled, heating will come on at 42° F. Both heating and cooling are power-on delayed by no less than 10 seconds. Anti-cycling of all heating and cooling stages is adjustable to up to 5 minutes. The number of cycles per hour for heating stages can be set between 3 and 8 cycles and for cooling 4 and 6 cycles. Temporary occupancy can be adjusted between 0 and 12 hours. The minimum deadband is adjustable between 2 and 4° F. Heating can be locked out on warm days and cooling can be locked out on cool days if an outside temperature sensor is installed or by subscribing to an outside air temperature server.

### **Runtime Monitoring**

Both heating and cooling stages are monitored for runtime using internal nonvolatile memory. Units of runtime measurement are hours.

## Hardware Considerations

### Hardware Requirements

The BAScontrol20 has 20 physical I/O points — eight universal inputs, four binary inputs, four binary outputs and four analog outputs. Although the application can be expanded to 2-stages each of heating and cooling, only single-stage operation is shown — requiring two outputs plus one for fan control. For 2-stage heating and cooling, a total of five binary outputs would be required. This can be accomplished by converting an analog output to a binary output through the use of an external relay.

Two analog inputs are required — one for space temperature and one for outside air temperature. If mechanical heating and cooling is not to be locked out based upon outside air temperature or if an outside air server is to be used instead, then the outside sensor need not be installed. In this application note, an outside temperature server is being used although an outside temperature sensor is installed as well. Two universal inputs (UI1 and UI2) are used for the two temperature inputs which are configured using a web browser. Configure UI1 and UI2 for a 10k type III thermistor and set its units to degrees-Fahrenheit. Single-point calibration can be accomplished using the configuration web pages. A temporary occupancy sensor is wired to binary input BI1.

The BAScontrol20 has a real-time clock which can be set manually or synchronized to a network time protocol (NTP) server from the Internet on a daily basis. Setup is through a web page. Daylight savings time can be configured as well. Scheduling logic is driven from this real-time clock. The clock is backed-up using a super-cap providing a minimum of seven-days of storage upon loss of power. The same storage is used for Sedona retentive counters and virtual points.

### Mechanical Equipment Wiring

In the adjacent figure, the necessary wiring to the mechanical equipment is shown using NEMA Standards Publication DC 3-2008 *Residential Controls — Electrical Wall-Mounted Room Thermostats* terminal markings. Notice that 24 VAC power is derived from a single control transformer located in the mechanical equipment. The BAScontrol20 is a Class 2 device and therefore Class 2 electrical wiring practice is followed.

Wiring to the mechanical equipment following common thermostat wiring practice.

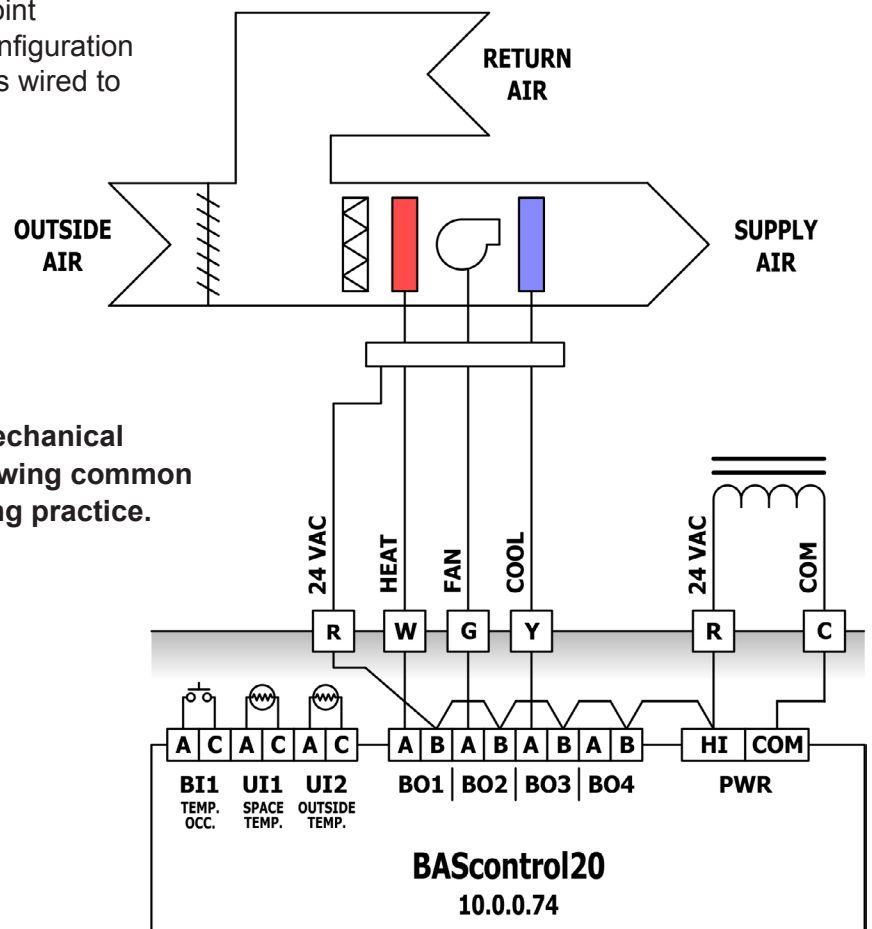

### Web-based Thermostat Features

The BAScontrol20 is both a BACnet/IP controller and a freely-programmable Sedona Framework controller. As a BACnet/IP device, it has an Ethernet connection and can serve up web pages. As a 20-point Sedona Framework device it can be programmed using Niagara Workbench if the proper manifest and kit files are installed in the Workbench tool. Since the BAScontrol20 does not have a local LCD display or keypad generally found on thermostats, this functionality can be emulated using web pages. Using a standard web browser, the systems integrator can read the space temperature, observe the current setpoint and change the thermostat mode. A local 7-day schedule resides in the unit. Every attempt has been made to match the functionality of popular commercial thermostats with the intent on educating systems integrators on how to develop wire sheets for use on similar heating/cooling applications. To accomplish this, custom Sedona components — called web components — have been developed to interface web pages to Sedona.

There are 48 web components (WC01–WC48) available in the CControls\_BASC20\_Web kit. These components can be configured to write data to a wire sheet or read data from a wire sheet using the Workbench tool. Once configured, all web components can be viewed or manipulated from web pages called web component pages. This was done to provide a convenient interface for the systems integrator to modify setpoints, schedule and other parameters of the web thermostat without requiring the use of a programming tool. Besides these custom web components, the remainder of the Sedona components are standard Sedona 1.2 Tridium released components or Contemporary Controls' custom I/O components unique to the BAScontrol20. If the control scheme needs to be altered the systems integrator can always use his workbench tool to make changes because the BAScontrol20 is a freely-programmable controller. If redesigned web pages or additional custom components are needed, Contemporary Controls is available to do the work.

### Accessing the Main Web Page

Configuring the universal inputs, virtual points and setting the real-time clock is via web pages using a standard web browser. A connection is made to the BAScontrol20 10/100 Mbps Ethernet port to a web browser using a common CAT5 Ethernet cable. The BAScontrol20 supports auto-negotiation and auto-MDIX. The LED next to the Ethernet port should flash once a connection is made. The default IP address of the BAScontrol20 is 192.168.92.68/24. Make sure the web browser is on the same subnet as the BAScontrol20. If successful, there will be a request for a User Name and Password. Enter the default settings of admin/admin. At that point the main BAScontrol20 web page should be visible.

The main web page displays the status of the BAScontrol20's 20 real I/O points plus eight virtual points. At the bottom of the screen is an Auto Refresh

button that allows for the periodic updating of the displayed data. If this feature is not wanted, just toggle the Auto Refresh button. There are four buttons just above the Auto Refresh button. Click on the System Configuration button to begin the configuration process.

The system configuration page has several sections including the IP Configuration section. Here you can change the IP settings if so desired. A static IP address is selected by default but the address can be changed by entering the new IP address, netmask and gateway settings. However, the BAScontrol20 also supports DHCP client so by selecting this mode a DHCP server on the attached network will supply the necessary IP settings for you. A gateway address setting is necessary if the NTP time server is going to be accessed or if the BAScontrol20 is to reside on a subnetted BACnet/IP network.

The screenshot displays the main web page of the BAScontrol20 thermostat. It features five columns of controls: Universal Inputs (UI1-UI8), Binary Inputs (BI1-BI4), Analog Outputs (AO1-AO4), Binary Outputs (BO1-BO4), and Virtual Points (VT1-VT8). Each control has a label, a value field, and a checkbox. The central area contains the large blue text 'BAScontrol20'. Below the controls are five buttons: System Configuration, System Status, Set Time, Web Components, and Restart Controller. At the bottom, there is an 'Auto Refresh OFF' indicator and a copyright notice: 'Copyright 2013 Contemporary Control Systems, Inc. All rights reserved. Firmware Revision 3.0.25 : Web Page Revision 4.0.6'.

**Main Web Page**

Access to configuration screens is via the main web page.

The screenshot shows the System Configuration web page. It is divided into two main sections: IP Configuration and BACnet Device Configuration. The IP Configuration section includes fields for IP Mode (Static IP), IP Address (10.0.0.74), Netmask (255.255.255.0), and Gateway (10.0.0.1). The BACnet Device Configuration section includes fields for Device Object Name (NW Unit Heater), Device Instance (245074), UDP Port (47808), BBMD IP Address (0.0.0.0), and BBMD Reg Time (100). Below these are sections for 'Enable Protocol' (with checkboxes for BACnet, Sedona, and FTP) and 'Authentication' (with fields for User Name 'admin' and Password '\*\*\*\*\*'). A note states: 'NOTE: You must click the Submit button to store any changes. Changes will not take effect until the controller has been restarted. You can restart the controller from the main page.' At the bottom are buttons for Kit Update, Create XML Files, Close, and Submit.

**System Configuration Web Page**

BACnet device object name and instance must be made unique from other BACnet devices.

The screenshot shows the Set Time web page. It is divided into two main sections: System Time and NTP Configuration. The System Time section includes dropdown menus for Year (2014), Month (February), Day (18), Hour (4), and Minute (49), along with a PM checkbox. The NTP Configuration section includes a dropdown for NTP (ENABLED), a text field for NTP Server (130.149.17.21), a dropdown for Time Zone (Central:UTC-6), and a text field for NTP Refresh (Days) (1). Below these is the DST Configuration section with a dropdown for Daylight Saving (ENABLED), and dropdowns for DST ON (March) and DST OFF (November), along with dropdowns for Day of Month (2nd SUN) and Hour (2). A note states: 'If enabled, the NTP server will be queried and the time will set at startup, and at midnight each refresh period.' At the bottom are buttons for Close and Submit.

**Set Time Web Page**

Time can be set manually or automatically if access to the Internet exists.

Web Components

<PREV
NEXT>

|      | Description                              | Value    | Wire Sheet   | Min | Max |
|------|--|----------|--------------|-----|-----|
| WC33 | Cooling Setpoint Occupied (CoSpO)        | 78       | Input ▼      | 65  | 85  |
| WC34 | Override Set (OvrIde)                    | 0.0      | Input ▼      | 0   | 1   |
| WC35 | Override Clear (OvrClr)                  | 0        | Input ▼      | 0   | 1   |
| WC36 | System Mode (0=Off,1=Heat,2=Cool,3=Auto) | 1        | Input ▼      | 0   | 3   |
| WC37 | Occupied                                 | 1.000000 | Output Bin ▼ | 0   | 1   |
| WC38 | Default Web Component 38                 | 0.0      | Input ▼      | 0   | 100 |
| WC39 | Default Web Component 39                 | 0.0      | Input ▼      | 0   | 100 |
| WC40 | Default Web Component 40                 | 0.0      | Input ▼      | 0   | 100 |

Auto Refresh ON
Close
Submit

### Configuring Web Components

Web components (WC01–WC48) are configured using a web browser. If the web component is configured as a wire sheet input — receives data from a web page and places it on a wire sheet — there are three output types available from the component. The float output (Flt Val) provides a floating point representation of the variable entered in the value box. The integer output (Int Val) would truncate any float value from the same location. The binary output (Bin Val) will present a true state for all values of 1 or above — float or integer. All other values entered are represented as false.

If the web component is configured as a wire sheet output — the wire sheet provides data to a web page — then the component must be configured as a FltOut, IntOut or BinOut by selecting Output Float, Output Int or Output Bin respectively. Only the corresponding variable type will be available to the web page.

For each web component configured, there is an opportunity to enter a description field or modify the default Min (0) and Max (100) limits on the variable's range. These limits only apply to any wire sheet inputs and are ignored for wire sheet outputs. Entering limit values for wire sheet input variables eliminates the need to provide limit logic in the Sedona wire sheet.

## BACnet Object List

The BAScontrol20 is BACnet compliant supporting the B-ASC device profile. By default, BACnet is enabled with a default Device Object Name and Device Instance which can be found on the system configuration page. If BACnet is to be used, assign unique values to both properties. On the same page the BACnet/IP Broadcast Management Device (BBMD) IP address and registration time can be set. Once entries are made, click Submit and Close. Changes will not take effect until the Restart

Controller button is clicked on the main web page.

What follows is the BACnet object list. Six objects are real BAScontrol20 I/O points and four are virtual points. Both real and virtual points must be configured using web pages where their BACnet parameters are assigned. Universal inputs require an additional step in that their type of input must be set. In this application the choice is 10k type III.

| BASC20 Point | Configured as    | Sedona Tag | Object Instance | BACnet Object Name             | Object Type |
|--------------|------------------|------------|-----------------|--------------------------------|-------------|
| UI1          | 10k type III     | SpTemp     | 1               | Space Temperature              | AI          |
| UI2          | 10k type III     | OATemp     | 2               | Outside Air Temperature        | AI          |
| BI1          | Binary in        | Ovr Sw     | 9               | Temporary Occupancy Switch     | BI          |
| BO1          | Binary out       | Heat       | 17              | Call for Heat                  | BO          |
| BO2          | Binary out       | Fan        | 18              | Fan                            | BO          |
| BO3          | Binary out       | Cool       | 19              | Call for Cool                  | BO          |
| VT1          | Wire Sheet Read  | HtRunT     | 201             | Heating runtime in hours       | AV          |
| VT2          | Wire Sheet Read  | CoRunT     | 202             | Cooling runtime in hours       | AV          |
| VT3          | Wire Sheet Write | OATsv      | 203             | Outside Air Temperature Server | AV          |
| VT4          | Wire Sheet Write | HumSv      | 204             | Outside Humidity Server        | AV          |

## Detailed Logic Description

Although wire sheets with dynamic viewing of variables is extremely helpful in understanding the logic, it can quickly get confusing as the complexity of the application increases. Therefore it is recommended to divide the

application into defined subsystems and restricting the logic on each subsystem to individual folders. For this example of a Web Thermostat, the recommended organization of wire sheets is:

- Main Wire Sheet (Sheet) — Real and virtual points plus four system folders
- Schedule Folder (Sched) — 7-day schedule logic for occupied/unoccupied operation
- Setpoint Folder (SetPt) — Heating and cooling setpoint logic
- Heating/Cooling Folder (HtCool) — 1-stage heating and 1-stage cooling logic
- Anti-cycling Folder (AntiCyc) — Anti-cycling logic for both heating and cooling



**Main Wire Sheet**

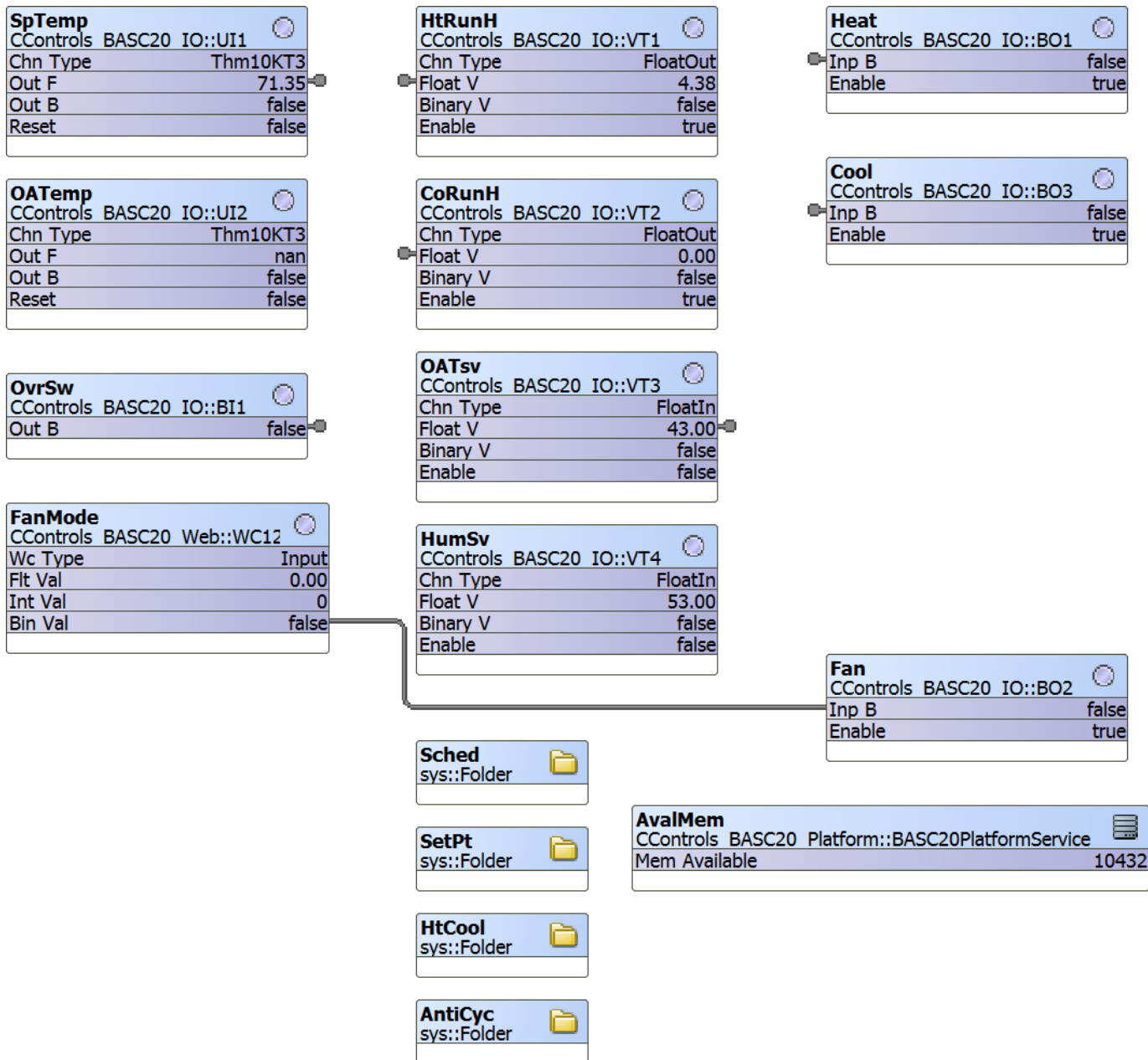

**Using Tabs in Workbench**

Here is one trick you can use to quickly move back and forth between the main wire sheet to folders. When you first display the main wire sheet, click on “ctrl-t” several times and you will notice tabs being created at the top of your wire sheet with the name “sheet.” Now click on one of the folders and you will notice that one of the “sheet” tabs has been converted to the name of the folder you just accessed. Now click on one of the “sheet” tabs and you will return to the main wire sheet. Click the next folder and you will see you created another tab for this folder. Once all the folders have been registered, you can quickly move between folders and the main wire sheet with ease by just clicking the corresponding tabs.

## Main Wire Sheet

Contemporary Controls has created a default main wire sheet with all real input and output components from the CControls\_BASC20\_IO kit placed onto the main wire sheet. Assuming BACnet is enabled in the controller, these 20 components will appear as BACnet objects consisting of four analog outputs (AO), four binary inputs (BI), four binary outputs (BO), and eight universal inputs (AI or BI). Also in this kit but not placed by default are eight virtual points (AV or BV) that can be used for wire sheet logic as retentive memory while appearing as BACnet objects. That leaves four retentive counters (UC1–UC4) from the same kit but these are not BACnet visible. Unused real points have been deleted from the main wire sheet.

Universal inputs must first be configured as either an AI or a BI using the controller's main configuration web page. Virtual points must likewise be configured as either an AV or BV. For example, clicking on the channel type description for UI1 sends you to the configuration page for UI1. This point has been configured as a type III 10k thermistor displaying degrees Fahrenheit. BACnet configuration, other than Object Instance which is predetermined, can be set on the same page. Universal points must be configured for channel types and then for BACnet while all other points can only be configured for BACnet. Once web page configuration is complete, Workbench can be used to name Sedona points. For example, UI1 has been renamed as space temperature (SpTemp) using Workbench. It is recommended that real inputs be aligned on the left side of the main wire sheet and real outputs on the right side for clarity. Virtual points could be configured as inputs or outputs and can be left in the middle of the wire sheet or spread out throughout the wire sheet logic.

There is one component that is on the main wire sheet and it is used to display available memory (AvalMem). It displays the dynamic usage of memory and it will decrease with the size of the wire sheets. Maintaining a value of less than 8,000 bytes is discouraged. This component is copied from CControls\_BASC20\_Platform and pasted onto the main wire sheet but only for convenience.

Folders can be found in the sys kit. For this application regular folders are being used. If rate folders (RateFolder) are used the execution of the logic is slower. What follows is a description of each folder.

## Sample Channel Configuration

The screenshot shows two web configuration pages. The top page is titled "BAS Channel Configuration" and includes a "Channel Type" dropdown menu set to "Therm 10kT3", a "Temperature Offset" input field with the value "0", and a "Temperature Units" dropdown menu set to "Fahrenheit". There are "Submit" and "Close" buttons. The bottom page is titled "BACnet Object Configuration" and includes an "Object Instance" input field with the value "1", an "Object Name" input field with the value "RTU-1 Space Temperature", an "Object Type" dropdown menu set to "Analog Input", an "Object Description" input field with the value "Thermistor located on wall", a "Units" dropdown menu set to "DEGREES\_FAHRENHEIT", and a "COV Increment" input field with the value "0". A "UI1" label is visible in the top right corner of the interface.

## Seven-Day Schedule Folder (Sched)

A seven-day schedule can be configured through the web component pages. Seven occupied times and seven unoccupied times (MonO through SunU) can be set for each day of the week. Occupied times are represented as minutes past midnight while unoccupied times are represented as minutes past the beginning of occupied times. These parameters feed seven daily schedule components (Mon through Sun). A datetimeSTD component (Clock) creates the time base. Day 1 is considered Monday while day 7 is Sunday. Selection logic, consisting of two de-multiplexers and AND/OR logic determine which of the seven schedules will be used to generate the Occupied variable (Occupy).

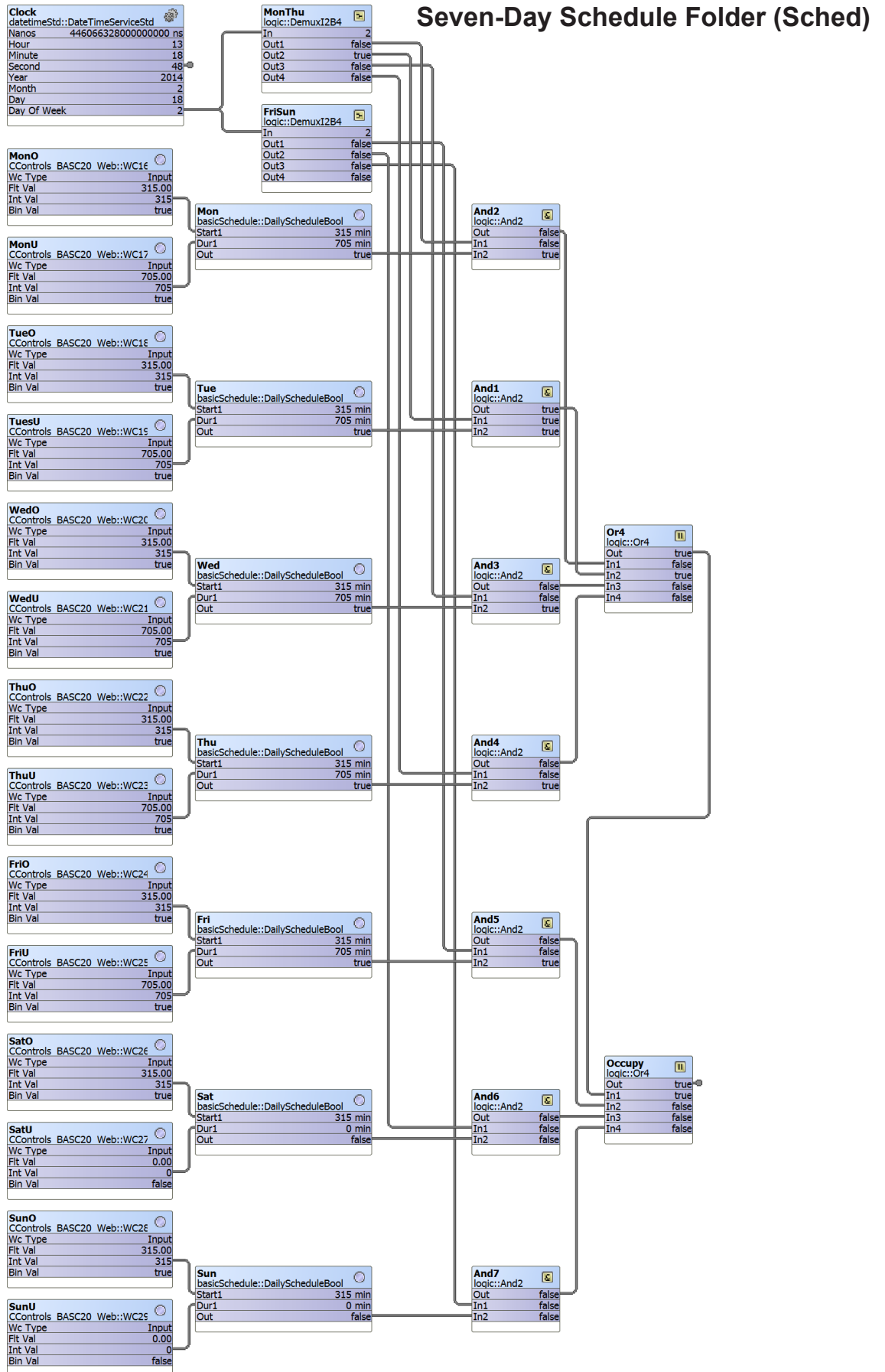

| Web Component | Sedona Tag | Significance<br>Default Value | Adjustment     |
|---------------|------------|-------------------------------|----------------|
| WC16          | MonO       | Monday occupied time — 0      | 0–1439 minutes |
| WC17          | MonU       | Monday unoccupied time — 0    | 0–1439 minutes |
| WC18          | TueO       | Tuesday occupied time — 0     | 0–1439 minutes |
| WC19          | TueU       | Tuesday unoccupied time — 0   | 0–1439 minutes |
| WC20          | WedO       | Wednesday occupied time — 0   | 0–1439 minutes |
| WC21          | WedU       | Wednesday unoccupied time — 0 | 0–1439 minutes |
| WC22          | ThuO       | Thursday occupied time — 0    | 0–1439 minutes |
| WC23          | ThuU       | Thursday unoccupied time — 0  | 0–1439 minutes |
| WC24          | FriO       | Friday occupied time — 0      | 0–1439 minutes |
| WC25          | FriU       | Friday unoccupied time — 0    | 0–1439 minutes |
| WC26          | SatO       | Saturday occupied time — 0    | 0–1439 minutes |
| WC27          | SatU       | Saturday unoccupied time — 0  | 0–1439 minutes |
| WC28          | SunO       | Sunday occupied time — 0      | 0–1439 minutes |
| WC29          | SunU       | Sunday unoccupied time — 0    | 0–1439 minutes |

### Setting the BAScontrol20 Clock

The BAScontrol20 clock can be set by first accessing the main configuration page and then clicking the Set Time button. On the resulting page the time can be set manually or by a Network Time Protocol (NTP) server. Daylight Savings Time (DST) can be observed as well. The real-time clock in the BAScontrol20 is backed up using a super-cap that provides a minimum of seven days of storage in the event the power is lost to the BAScontrol20.

### Setpoint Logic Folder (SetPt)

The occupied and unoccupied heating and cooling setpoints are provided by web components (HtSpO, HtSpU, CoSpO, CoSpU). All four have limits that ensure that the heating range remains between 60° and 80° F and the cooling range remains between 65° and 85°. These limits can be changed in the web component. The occupied variable (Occupy) from the schedule folder is used to select the occupied heating and cooling setpoints through selectors (HtSpS, CoSpS). In an occupied or temporary occupied state, the occupied setpoints are selected otherwise the unoccupied setpoints are selected.

There are other web components provided with preset limits. The dead-band (DB) parameter can range from 2 to 4. The maximum heating (HtMax) parameter can range from 40° to 90°F. The minimum cooling (CoMin) can range from 54° to 100 °F. Temporary occupancy (TmpOcc) can range from 0 to 12 hours. This value is multiplied by 60 in order to convert to seconds for programming the timers. Two binary inputs — override and override clear — (Ovrde, OvrClr) are required. In addition, the real binary input B1 can be used to initiate a temporary occupied condition if the temperature sensor is equipped with an override button.

## Application Note — Creating a Web-based Thermostat Using the BAScontrol20

If the override button on the web page or B1 is pressed, the SRLatch (TmpLat) is set indicating a temporary occupied condition and a timeout begins. Once the timer (TmpOccT) times out, a one-shot is fired clearing the override timer. This timer can also be cleared by pressing the override clear button.

The selected heating setpoint (HtSpS) is first compared to the high temperature limit (HtMaxL) before passing (HeatL) to the dead-band logic. The selected cooling setpoint (CoSpS) is likewise compared to the low temperature limit (CoMinL) before passing (CoolL) to the dead-band logic.

The dead-band logic ensures that the cooling setpoint exceeds the heating setpoint by the configured dead-band amount. If by increasing the heating setpoint causes the setpoint to enter the dead-band range, the cooling setpoint will automatically be increased to maintain the dead-band limit. This is more important in the Auto mode but the logic is the same in the Heat or Cool modes. Once this check is completed, the two setpoints (HeatSp, CoolSp) are sent to the heating and cooling logic folder.

| Web Component | Sedona Tag | Significance<br>Default Value                               | Adjustment   |
|---------------|------------|---|--|
| WC03          | HtMax      | Maximum heating setpoint limit<br>Default = 80 °F           | Maximum occupied or unoccupied heating setpoint with a range of 40 to 90 °F.   |
| WC04          | CoMin      | Minimum cooling setpoint limit<br>Default = 54 °F           | Minimum occupied or unoccupied cooling setpoint with a range of 54 to 100 °F.  |
| WC08          | DB         | Minimum deadband<br>Default = 2.0 °F                        | Minimum deadband value between the heating and cooling setpoints. Range is 2 to 4 °F.  |
| WC09          | TmpOcc     | Temporary occupancy time<br>Default = 2 hours               | Temporary occupancy time with occupied mode setpoints when override function is enabled. Range is 0 to 12 hours.                       |
| WC10          | hLock      | Outside air temperature heating lockout<br>Default = 120 °F | Disables heating stage operation based on outdoor air temperature. Range is –15 to 120 °F. (Assumes outside air sensor or OAT server.) |
| WC11          | cLock      | Outside air temperature cooling lockout<br>Default = 40 °F  | Disables cooling stage operation based on outdoor air temperature. Range is 40 to 95 °F. (assumes outside air sensor or OAT server).   |
| WC30          | HtSpU      | Unoccupied heating setpoint                                 | Range is 60 to 80 °F   |
| WC31          | HtSpO      | Occupied heating setpoint                                   | Range is 60 to 80 °F   |
| WC32          | CoSpU      | Unoccupied cooling setpoint                                 | Range is 65 to 85 °F   |
| WC33          | CoSpO      | Occupied cooling setpoint                                   | Range is 65 to 85 °F   |
| WC34          | OvrIde     | Override occupancy state<br>Default = false                 | Overrides the current occupancy state to become temporary occupied. Pulse to true and then return to false.                            |
| WC35          | OvrClr     | Override clear<br>Default = false                           | Clears the temporary occupied state. Pulse to true and then return to false.   |

**Setpoint Logic Folder (SetPt)**

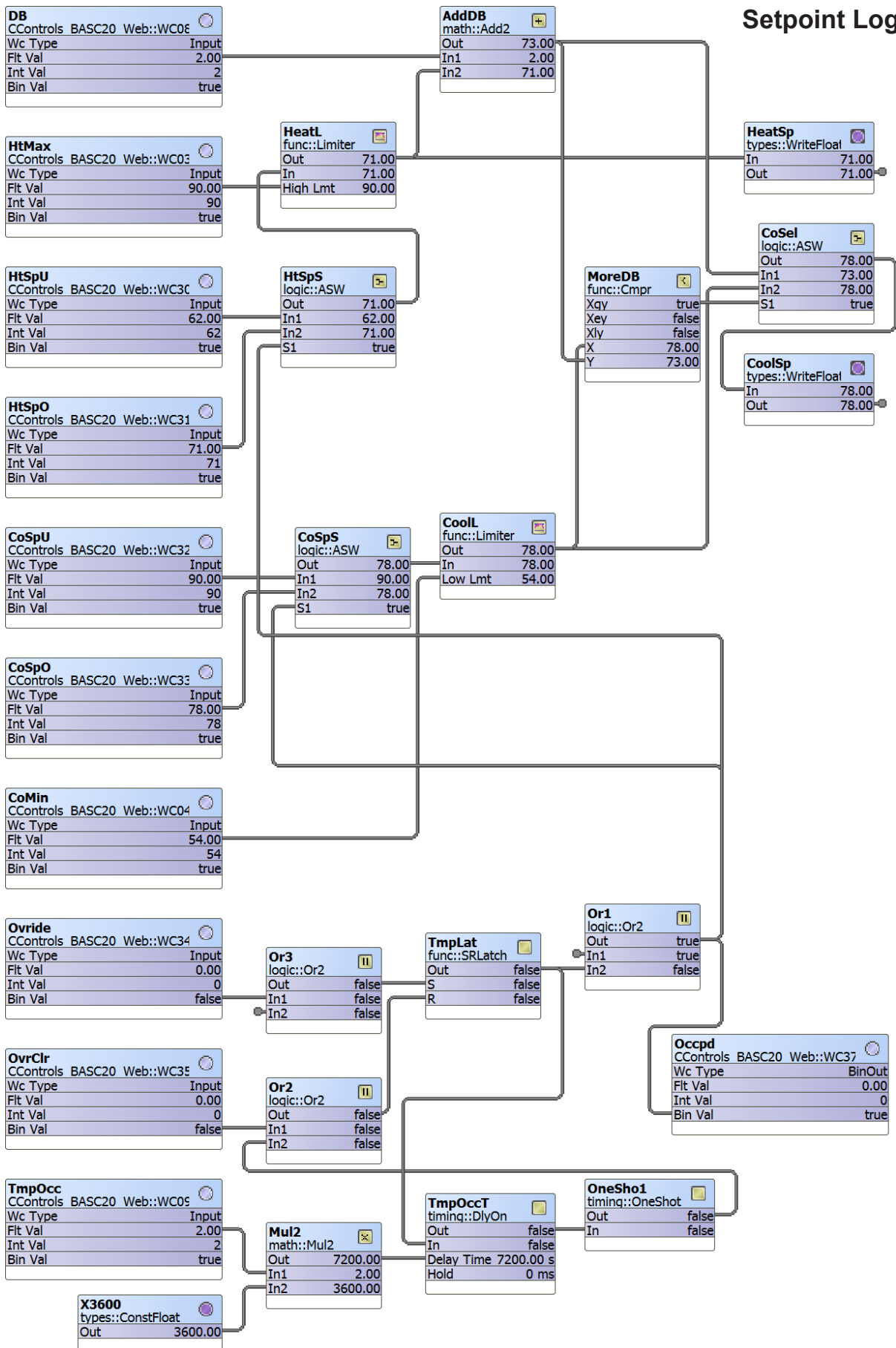

### Heating and Cooling Logic Folder (HtCool)

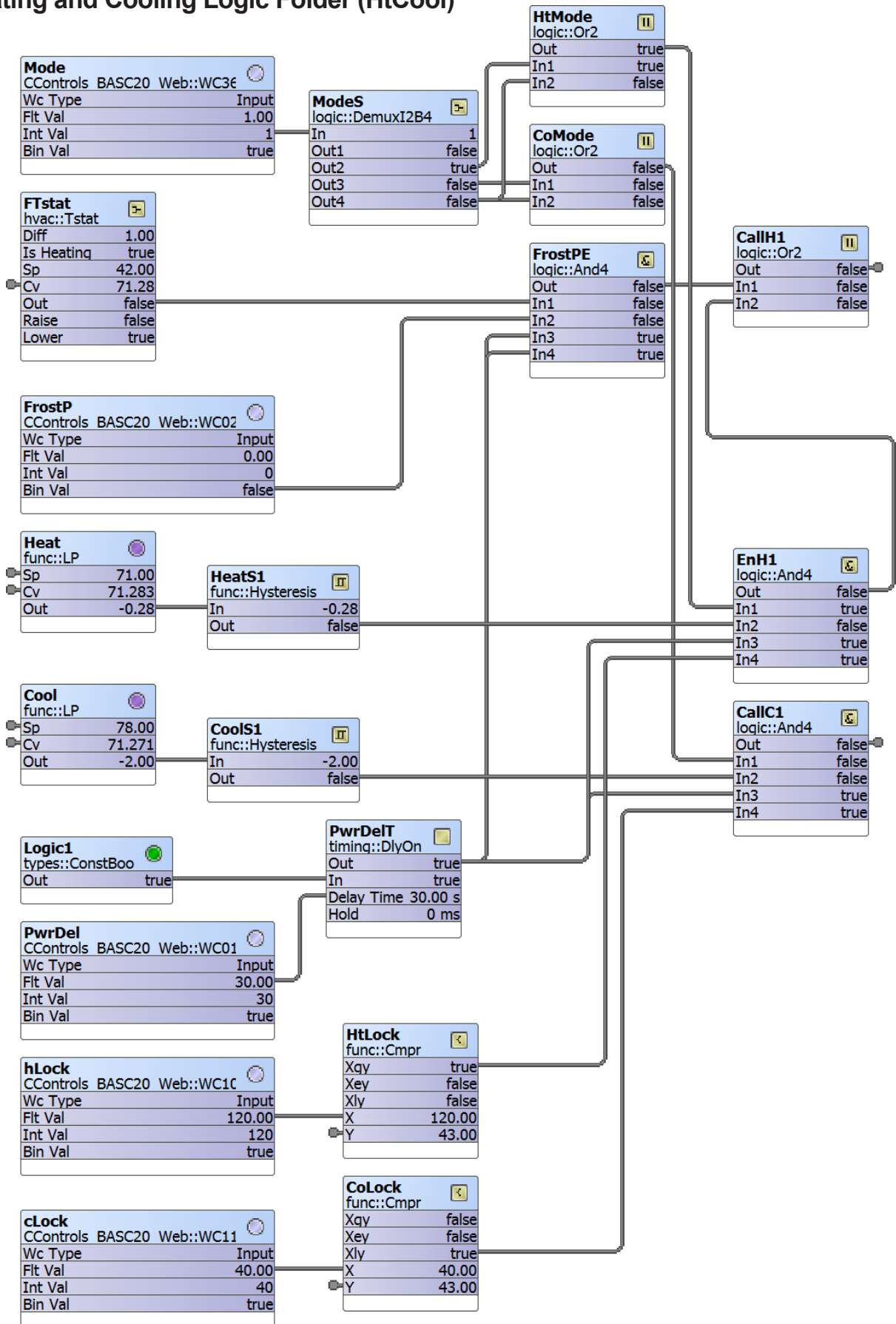

### Heating and Cooling Logic Folder (HtCool)

The web thermostat has four operating modes — *Off*, *Heat*, *Cool* and *Auto*. A web component (Mode) provides a range of mode values between 0 and 3.

- 0 indicates *Off*
- 1 indicates *Heat*
- 2 indicates *Cool*
- 3 indicated *Auto*

The four possible states are decoded (ModeS) and are used to enable heating and cooling depending upon the mode.

There are two LP components (Heat, Cool) that are enabled continuously. The Heat LP component is set for indirect acting while the Cool LP component is set for direct acting. The controlled variable (Cv) for both is the space temperature (SpTemp) which comes from the main wire sheet. The setpoints (HeatSp, CoolSp) come from the SetPt folder. Only the P and I parameters are programmed and not the D parameter therefore making the two LP components PI controllers. The proportional gain (P) is set to one meaning that the output would be the difference between the setpoint and the controlled variable in degrees Fahrenheit if there was no integral gain (I) programmed. Some integral gain will make the output response smoother but there is an opportunity for integral windup in the LP components when switching from heating mode to cooling mode. The best way to limit the integral windup is to limit the output range.

With a PI controller, output bias is not supported in the LP component. Therefore if there is no input error the output of the controller will be zero. Any value above zero would be a call for heating in the Heat LP component and a call for cooling in the Cool LP component. An output of one would indicate a one degree deviation from setpoint. Since we would want our temperature control tighter than one degree we will set the proportional band arbitrarily to  $\pm 2^\circ$  by setting Max to 2 and Min to -2 in the two LP components. This will limit the integral windup to these two values allowing the control to recover quicker during a mode change. If we try different values for P and I while the LP components are controlling, the output might jump so we will limit the output slew rate (Max Delta) to 0.1. All these parameters can be changed in the LP components for better control.

Each LP component feeds a hysteresis component that converts the analog output of the LP components into digital outputs for heating or cooling. The trip points are configured such that an output will trigger first when the LP output exceeds a particular rising positive value set in the hysteresis component. This same output will go false at a different falling value. Sufficient hysteresis is provided to guard against short cycling. The trip points are “tuned” for minimum error and minimum overshoot with a concern for not introducing excessive cycling of the mechanical equipment. The two hysteresis component outputs are fed to gating logic before they become call-for-heating or call-for-cooling commands (CallH1, CallC1). These commands are disabled if the mode is set to *Off* or if the power-on delay timer has not timed out (set for 30 seconds). The heating command is enabled during *Heat* and *Auto* while the cooling command is enabled during *Cool* and *Auto*.

If frost protection (FrostP) is enabled, a simple thermostat component (FTstat) is enabled to ensure that there will be a call-for-heat independent of the heating setpoint or operating mode. The thermostat has a 42° F trip point with a one degree deadband. Only CallH1 will come on with the frost thermostat.

The hLock and cLock web components are compared to the outdoor air temperature (OATemp from the main wire sheet). If the OAT is greater than the heat lockout temperature, heating is disabled. If the OAT is less than the cooling lockout temperature, cooling is disabled. OAT can be measured using analog input UI2 or by the virtual point VT3. In this example of the web thermostat, VT3 is being supplied by a BACnet client that is subscribing to a local temperature/humidity server on the Internet. VT4 provides outside humidity measurement but is not used.



| Web Component | Sedona Tag | Significance<br>Default Value                                 | Adjustment   |
|---------------|------------|---|--|
| WC01          | PwrDel     | Power-up delay<br>Default = 30 seconds                        | On power-up of the thermostat there will be no heating or cooling until this time has expired. Range is 10 to 120 seconds. |
| WC02          | Frost      | Frost protection enabled<br>Default = Off                     | Off: no room frost protection<br>On: 42 °F protection regardless of thermostat mode  |
| WC36          | Mode       | Operating mode<br>1 = off<br>2 = heat<br>3 = cool<br>4 = auto | 1, 2, 3 and 4  |

### Anti-cycling Logic Folder (AntiCyc)

There are two possible anti-cycling inhibits to engaging a heating or cooling stage. The first inhibit is to delay the restart of a stage within a minimum delay time and the second is to not engage a stage if the number of starts exceeds the maximum number of cycles per hour. Anti-cycling logic exists for each heating and cooling stage.

The Anti-cycle (AntiC) configuration setting (0 to 5 minutes) pertains to both heating and cooling. If the mechanical equipment has built-in anti-cycle logic set this parameter to zero. The parameter is limited to ensure the value remains in the 0–5 minute range. The value is multiplied by 60 in order to convert this time to seconds for programming the Anti-cycling timer (AntiCT).

A call-for-heating or call-for-cooling is sent to an AND gate and then after a short time delay to the command timer (Cmd). This command timer signal is the one that commands a heating or cooling stage to be active. It is actually an off-delay timer that will continue to command heating or cooling for a fixed duration after a call-for-heat or call-for-cool. The timer is arbitrarily set to 15 seconds. Once this command signal is off, the anti-cycle timer (AntiCT) will prevent a new cycle from starting until it times out.

Each time the anti-cycle timer times out, the cycle-counter (CycCtr) is incremented by one. If initially the hour-timer (HourT) is cleared, the first instance of a command signal will begin a timing cycle via a comparator (NotZ). After an hour, the hour-timer (HourT) will clear the cycle-counter and counting along with hour-timing will resume at the end of the next command sequence.

There are separate heating (HtCph) and cooling (CoCph) cycles-per-second configuration settings. These settings are limited to restrict the range between 3 to 8 cycles-per-hour for heating and between 4 to 6 cycles-per-hour for cooling. These values set the upper limit of a comparator (CountL). Once the limit is reached, the next command cycle is disabled to the appropriate heating or cooling stage by the same AND gate used for anti-cycling. A short on-delay timer (DlyCmd) is used to guard against any race conditions with the cycle limiting logic.

### Anti-cycling Logic Folder (AntiCyc)

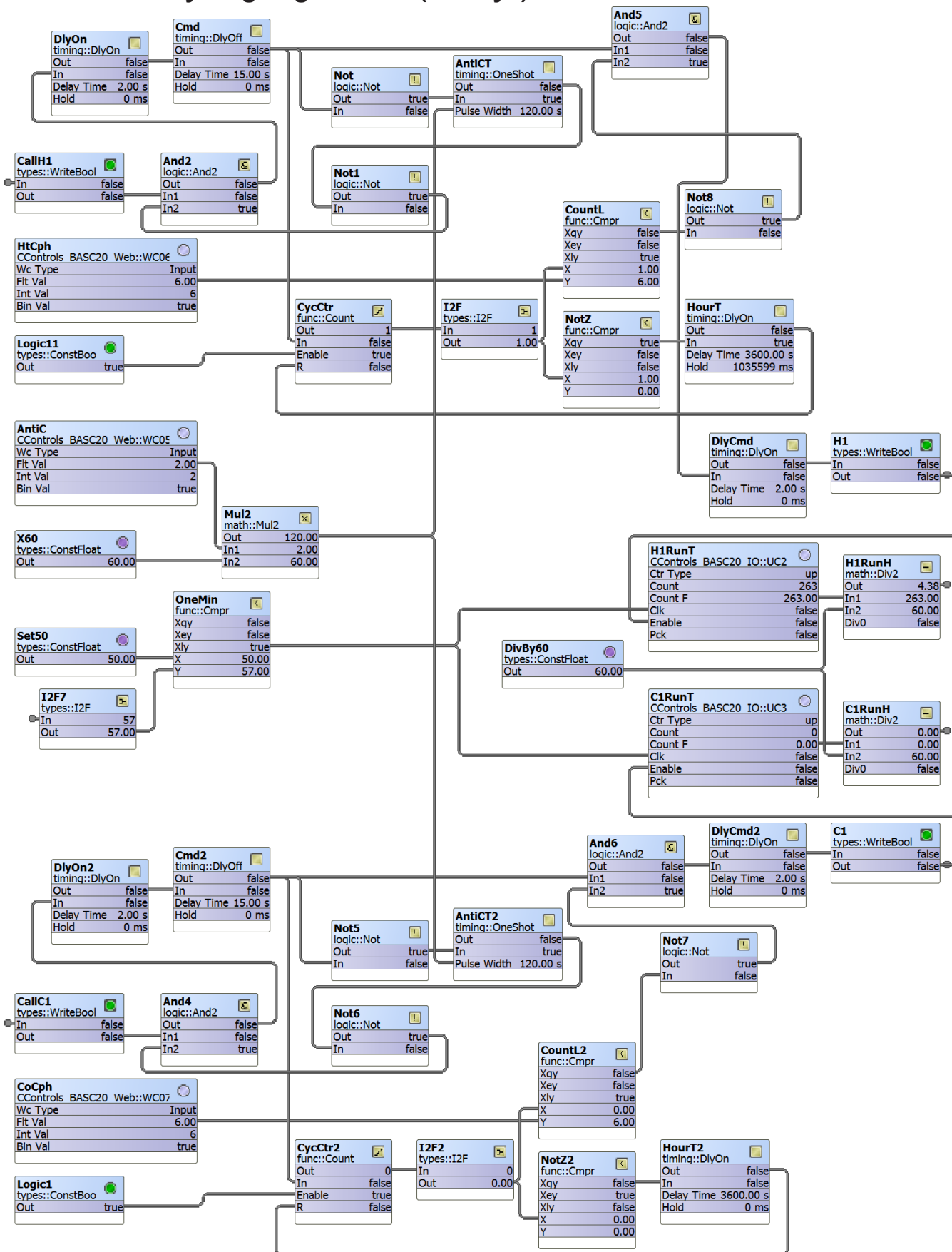

## Application Note — Creating a Web-based Thermostat Using the BAScontrol20

The FanMode web component connects to the BO2 binary output on the main wire sheet. The fan will come on if the FanMode web component indicates *true*.

There are two retentive counters (H1RunT and C1RunT) that receive a clock source from a comparator (OneMin). The comparator inputs are the seconds clock (Clock in the Sched folder) and the constant 50.

When the two values agree a one minute pulse increments the two counters assuming that their corresponding enable inputs (H1, C1) are *true*. The use of 50 for comparison is arbitrary. By dividing the counter outputs by 60 results in running times for heating and cooling in hours. This data is provided to VT1 and VT2 for reading by a BACnet client.

| Web Component | Sedona Tag | Significance<br>Default Value                                | Adjustment  |
|---------------|------------|--|---|
| WC05          | AntiC      | Minimum on/off operation time for stages<br>Default = 2 mins | Minimum on/off time for cooling & heating stages. Set to zero if heating/cooling unit has its own built-in protection. Range is 0 to 5 minutes.   |
| WC06          | HtCph      | Heating stages cycles per hour<br>Default = 6                | Used to minimize equipment wear. Range is 3 to 8 cycles per hour.   |
| WC07          | CoCph      | Cooling stages cycles per hour<br>Default = 6                | Used to minimize equipment wear. Range is 4 to 6 cycles per hour.   |
| WC12          | FanMode    | Fan mode operation<br>Auto = false; default state<br>On=true | The fan is usually controlled by the mechanical equipment. During cooling it is on and during heating it is on if the plenum is sufficiently hot. This would be Auto operation. However, the fan can be turned on independent of the state of the mechanical equipment. |

## Using Java Script for the Web Interface

This application note details the inherent capabilities of the BAScontrol20 in interfacing control logic with hosted web pages. The method used involved the development of web components to carry wire sheet data between the wire sheet and web pages served up by the BAScontrol20. To demonstrate the concept, a basic web component page was created that serves as a simple browser interface to the controller allowing the systems

integrator the opportunity to make parameter changes to the controller without the need of the Workbench tool. A skilled Java Script programmer can exploit this capability by making custom web pages with a completely different look and feel to the generic web component pages while utilizing the same 48 web components available in the BAScontrol20. Other application notes will provide examples on how this can be done.

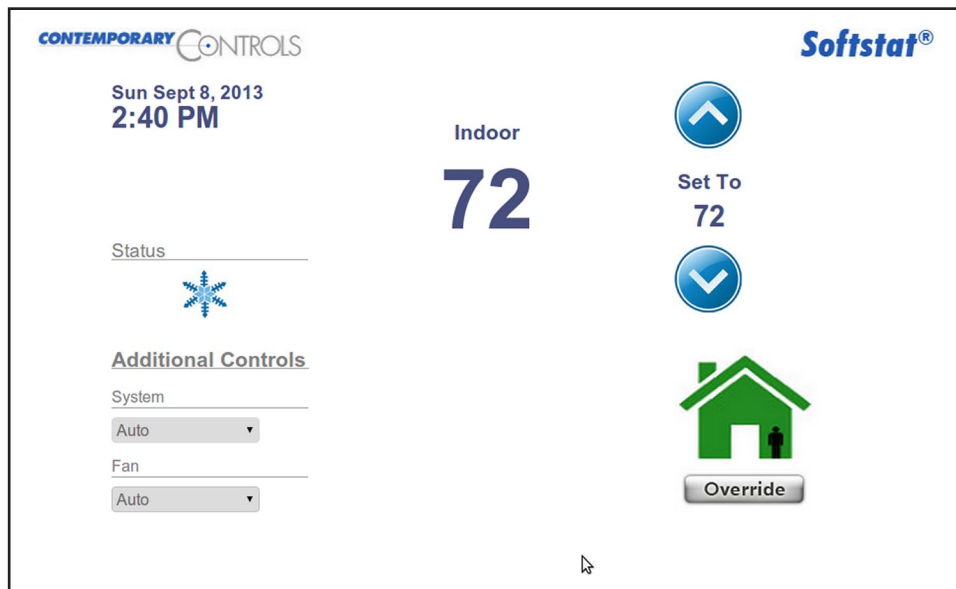

### United States

Contemporary Control Systems, Inc.  
2431 Curtiss Street  
Downers Grove, IL 60515  
USA

Tel: +1 630 963 7070  
Fax: +1 630 963 0109

[info@ccontrols.com](mailto:info@ccontrols.com)  
[www.ccontrols.com](http://www.ccontrols.com)

### China

Contemporary Controls (Suzhou) Co. Ltd  
11 Huoju Road  
Science & Technology Industrial Park  
New District, Suzhou  
PR China 215009

Tel: +86 512 68095866  
Fax: +86 512 68093760

[info@ccontrols.com.cn](mailto:info@ccontrols.com.cn)  
[www.ccontrols.asia](http://www.ccontrols.asia)

### United Kingdom

Contemporary Controls Ltd  
14 Bow Court  
Fletchworth Gate  
Coventry CV5 6SP  
United Kingdom

Tel: +44 (0)24 7641 3786  
Fax: +44 (0)24 7641 3923

[info@ccontrols.co.uk](mailto:info@ccontrols.co.uk)  
[www.ccontrols.eu](http://www.ccontrols.eu)

### Germany

Contemporary Controls GmbH  
Fuggerstraße 1 B  
04158 Leipzig  
Germany

Tel: +49 341 520359 0  
Fax: +49 341 520359 16

[info@ccontrols.de](mailto:info@ccontrols.de)  
[www.ccontrols.eu](http://www.ccontrols.eu)